



Equipped with AEM® Dryflow™ Filter  
No Oil Required!

## **INSTALLATION INSTRUCTIONS**

### **PART NUMBER:**

**21-508B (Blue Finish)**

**21-508C (Gun Metal Grey Finish)**

**21-508R (Red Finish)**

---

2002-2005 HONDA Civic Si L4-2.0L C.A.R.B. E.O. # D-670-15

**AEM® bypass valves are not compatible with this intake system (part number 21-508)  
DO NOT attempt to install an AEM bypass valve on this intake system!**

**Intake systems for vehicles listed are 50  
state legal. See [AEMIntakes.com](http://AEMIntakes.com) for CARB  
status on each part for a specific vehicle.**

## PARTS LIST

Description	Qty.	Part Number
Element Parts Kit 2.50 X 5" Dry Ele.	1	21-201DK
Inlet Pipe	1	2-508
Hose, Adapter 2.50/2.75 X 3" Bl.	1	5-257
Hose; 3/4"ID X 30"L	1	5-4030
Hose; 3/8"ID X 28"L	1	5-1028
Mount, Rubber 1" X 8mm	1	1228560
Grommet, 13/32"	1	784639
Washer, 8mm Soft Mount	1	559960
Nut, M8 Hex Serrated	1	444.460.08
Hose Clamp, 3/4"	2	4093-5
Hose Clamp, 1 1/4" Narrow	2	08420
1/2" Bnd. Hose Clamp, 2.15-3.00"	1	9440
1/2" Bnd. Hose Clamp, 2.31-3.25"	2	9444

Read and understand these instructions **BEFORE** attempting to install this product. Failure to follow installation instructions and not using the provided hardware may damage the intake tube, throttle body and engine.

The AEM<sup>®</sup> intake system is a performance product that can be used safely during mild weather conditions. During harsh and inclement weather conditions, you must return your vehicle to stock OEM air box and intake tract configuration. Failure to follow these instructions will void your warranty.

## 1. Preparing Vehicle

- a. Make sure vehicle is parked on level surface.
- b. Set parking brake.
- c. If engine has run in the past two hours, let it cool down.
- d. Disconnect negative battery terminal.
- e. Raise the front of the vehicle with a jack. Refer to your owner's manual for proper jack and jack stand placement to properly support vehicle. Support your vehicle using properly rated jack stands before wheel removal or while working under the vehicle.

**NEVER WORK UNDER A VEHICLE WITHOUT USING JACK STANDS.**

- i. Remove the front driver side wheel.
  - ii. Remove the driver side inner fender well liner.
- f. Do not discard stock components after removal of the factory system.

## 2. Removal of stock system

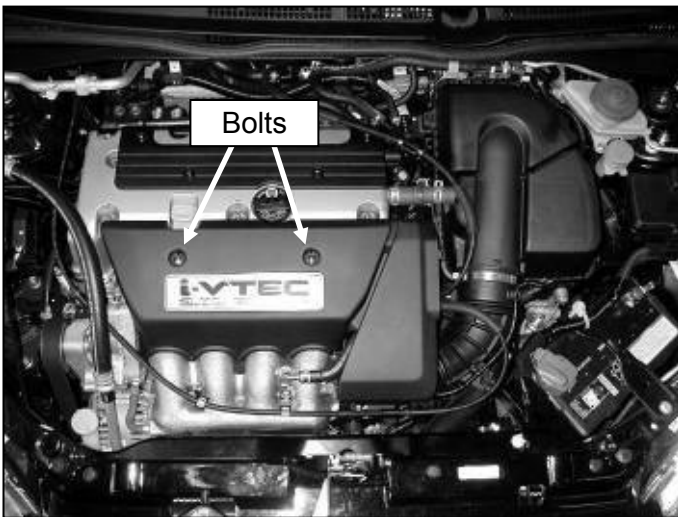

a. Remove the two bolts that secure the engine cover. Remove the engine cover from the vehicle.

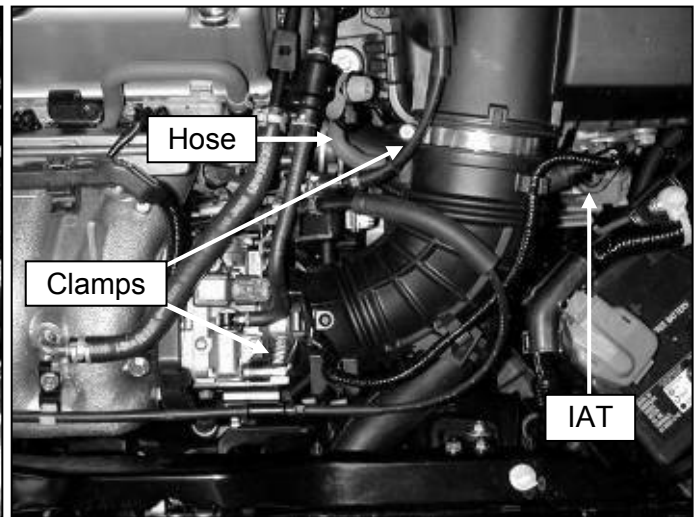

b. Loosen the two clamps securing the intake tube to the throttle body and air box assembly. Remove the hose attached to the intake tube. Unplug the intake air temperature sensor (IAT), then carefully remove the IAT and set aside in a safe area.

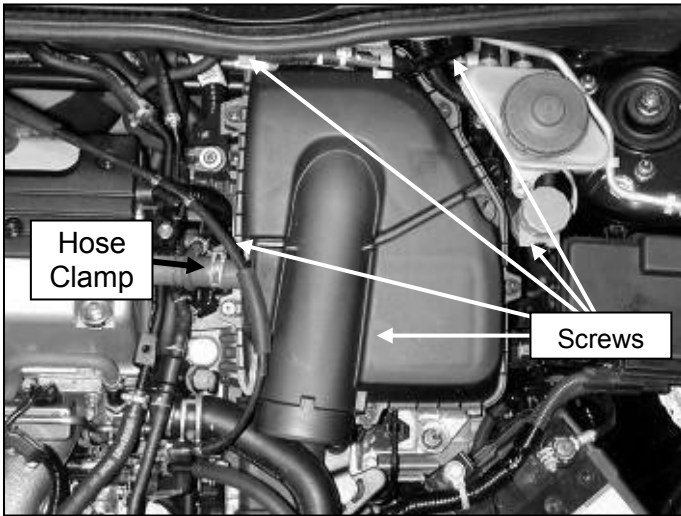

c. Loosen the 5 phillips head screws and remove the air filter assembly lid. Disconnect the breather hose by releasing the hose clamp.

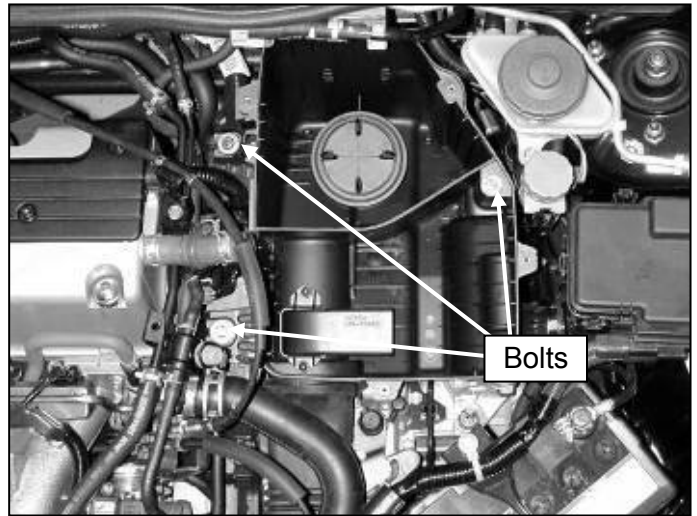

d. Loosen the 3 bolts securing the air filter assembly. Remove the air filter assembly from the vehicle.

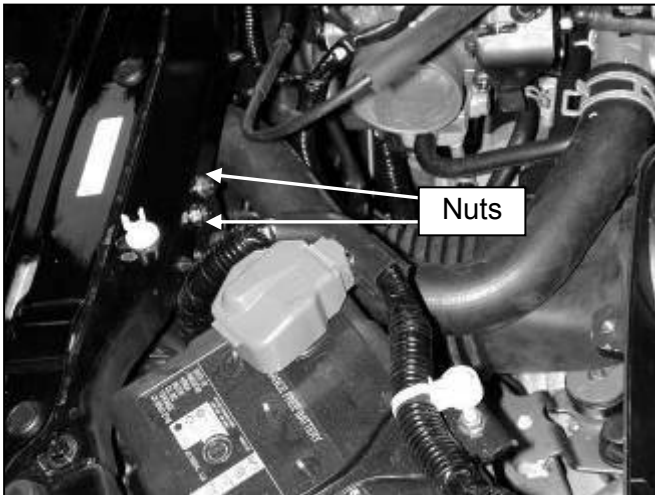

e. Loosen the two nuts securing the air tube. Remove the air tube from the vehicle.

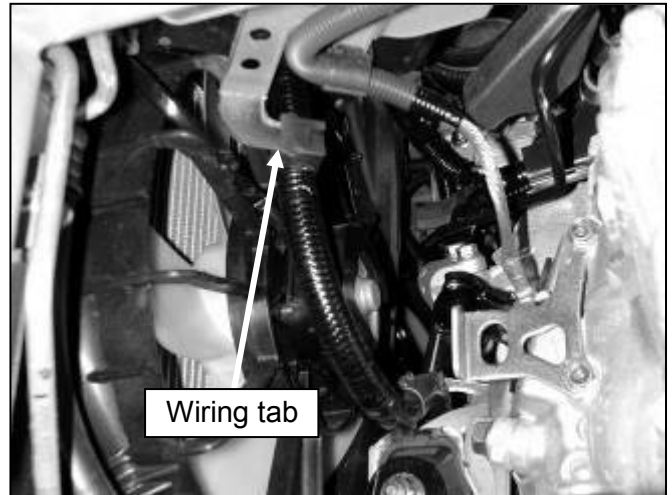

f. Bend the wiring mount tab towards the radiator so there is clearance for the intake pipe.

### 3. Installation of AEM® intake system.

a. When installing the intake system, do not completely tighten the hose clamps or mounting hardware until instructed to do so.

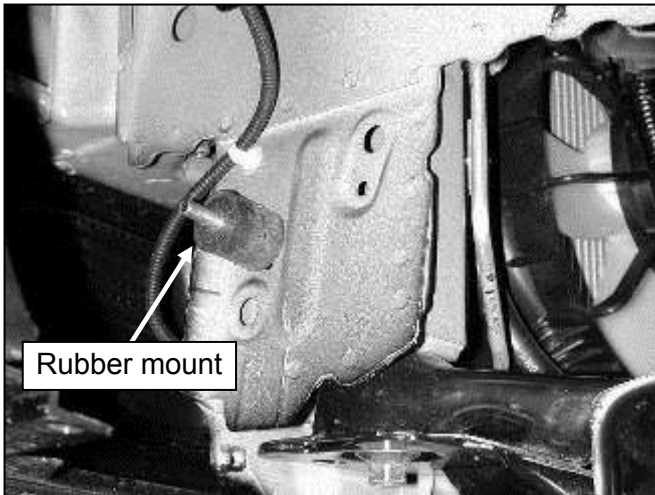

b. Install the rubber mount in the factory threaded hole as shown.

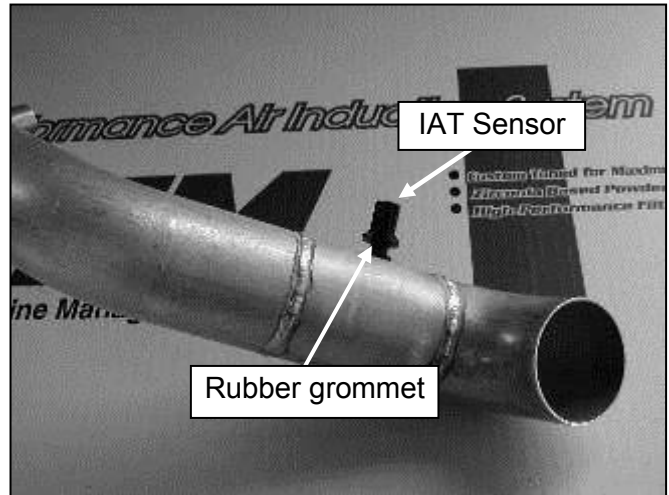

c. Install the supplied rubber mount into the intake pipe. Install the factory IAT sensor into the grommet on the intake pipe.

**NOTE: Ensure you do not push the grommet into the intake pipe.**

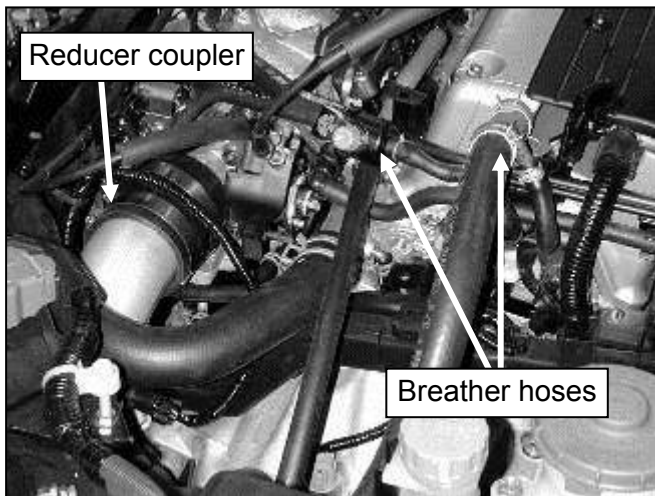

d. Install the intake pipe using the included reducer coupler and hose clamps. Replace the factory breather hoses with the supplied hoses and secure them with the included hose clamps.

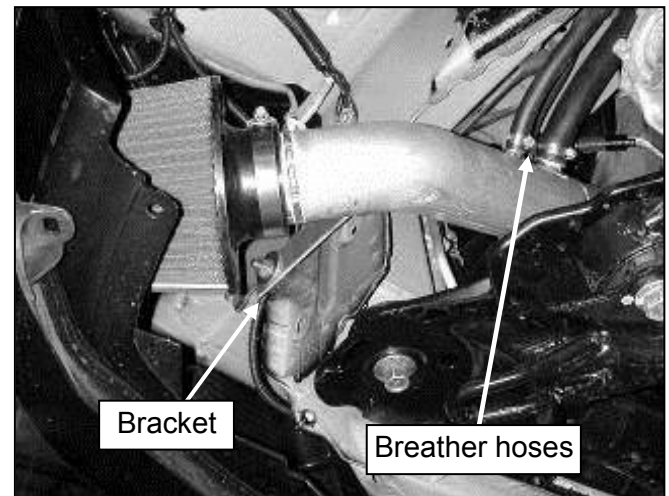

e. Install the air filter and position for best fitment. Secure the intake pipe's bracket to the rubber mount with a washer and serrated nut. Refer to the diagram on the next page for the proper installation of the rubber mount assembly. Secure the breather hoses to the intake pipe nipples and secure with hose clamps.

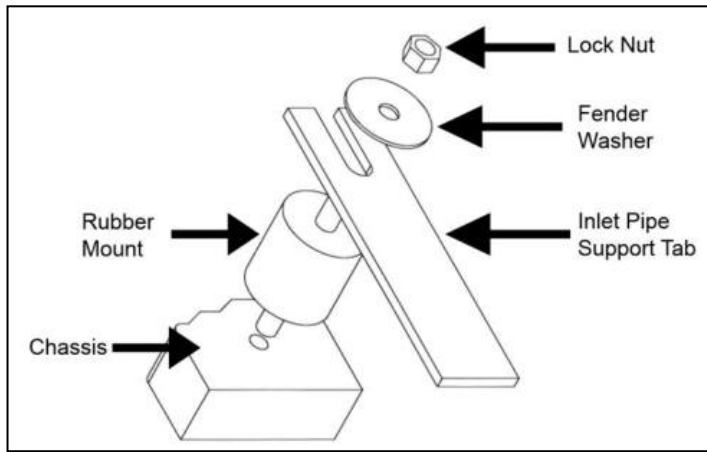

f. Proper installation of the rubber mount assembly.

#### 4. Reassemble Vehicle

- a. **IAT Sensor:** Plug the IAT wiring harness back into the IAT sensor.
- b. **Fender Liner:** Install the fender liner and any hardware that was removed in steps 1eii.  
**NOTE: Failure to install the fender liner will result in diminished performance and increase the potential for engine damage due to water ingestion in rainy conditions.**
- c. **Wheel:** Install the driver's side wheel using the factory torque specification (see owner's manual).
- d. Position the inlet pipes for the best fitment. Be sure that the pipes or any other components do not contact any part of the vehicle. Tighten the rubber mount, all bolts, and hose clamps.
- e. Check for proper hood clearance. Re-adjust pipes if necessary and re-tighten them.
- f. Inspect the engine bay for any loose tools and check that all fasteners that were moved or removed are properly tightened.
- g. Reconnect negative battery terminals and start engine. Let the vehicle idle for 3 minutes. Perform a final inspection before driving the vehicle.
- h. Please note that AEM<sup>®</sup> bypass valves will not work with this application (part number 21-508). The use of a bypass valve could have adverse effects on the performance of the system.

#### 5. CARB Sticker Placement

- a. The C.A.R.B. exemption sticker, (attached), must be visible under the hood so that an emissions inspector can see it when the vehicle is required to be tested for emissions. California requires testing every two years, other states may vary.

#### 6. Service and Maintenance

- a. It is recommended that you service your AEM<sup>®</sup> Dryflow™ filter every 20,000 miles for optimum performance. Use AEM Dryflow cleaning kit part # 21-110.
- b. Use aluminum polish to clean your polished AEM<sup>®</sup> intake tube.
- c. Use window cleaner to clean your powder coated AEM<sup>®</sup> intake tube. **(NOTE: DO NOT USE aluminum polish on powder coated AEM intake tubes).**

For technical inquiries  
 e-mail us at  
[sales@aemintakes.com](mailto:sales@aemintakes.com)  
 or  
 call us at  
 800.992.3000

## **AEM Air Intake System Warranty Policy**

AEM® warrants that its intake systems will last for the life of your vehicle. AEM will not honor this warranty due to mechanical damage (i.e. improper installation or fitment), damage from misuse, accidents or flying debris. AEM will not warrant its powder coating if the finish has been cleaned with a hydrocarbon-based solvent. The powder coating should only be cleaned with a mild soap and water solution. Proof of purchase of both the vehicle and AEM intake system is required for redemption of a warranty claim.

This warranty is limited to the repair or replacement of the AEM part. In no event shall this warranty exceed the original purchase price of the AEM part nor shall AEM be responsible for special, incidental or consequential damages or cost incurred due to the failure of this product. Warranty claims to AEM must be transportation prepaid and accompanied with dated proof of purchase. This warranty applies only to the original purchaser of product and is nontransferable. Improper use or installation, use for racing, accident, abuse, unauthorized repairs or alterations voids this warranty. AEM disclaims any liability for consequential damages due to breach of any written or implied warranty on all products manufactured by AEM. Warranty returns will only be accepted by AEM when accompanied by a valid Return Merchandise Authorization (RMA) number. Credit for defective products will be issued pending inspection. Product must be received by AEM within 30 days of the date RMA is issued.

If you have a warranty issue, please call (800) 992-3000 and our customer service department will assist you. A proof of purchase is required for all AEM warranty claims.

**Intake systems for vehicles listed are 50 state legal. See [AEMIntakes.com](http://AEMIntakes.com) for CARB status on each part for a specific vehicle.**