

**GT**  
**MOMENTUM™**

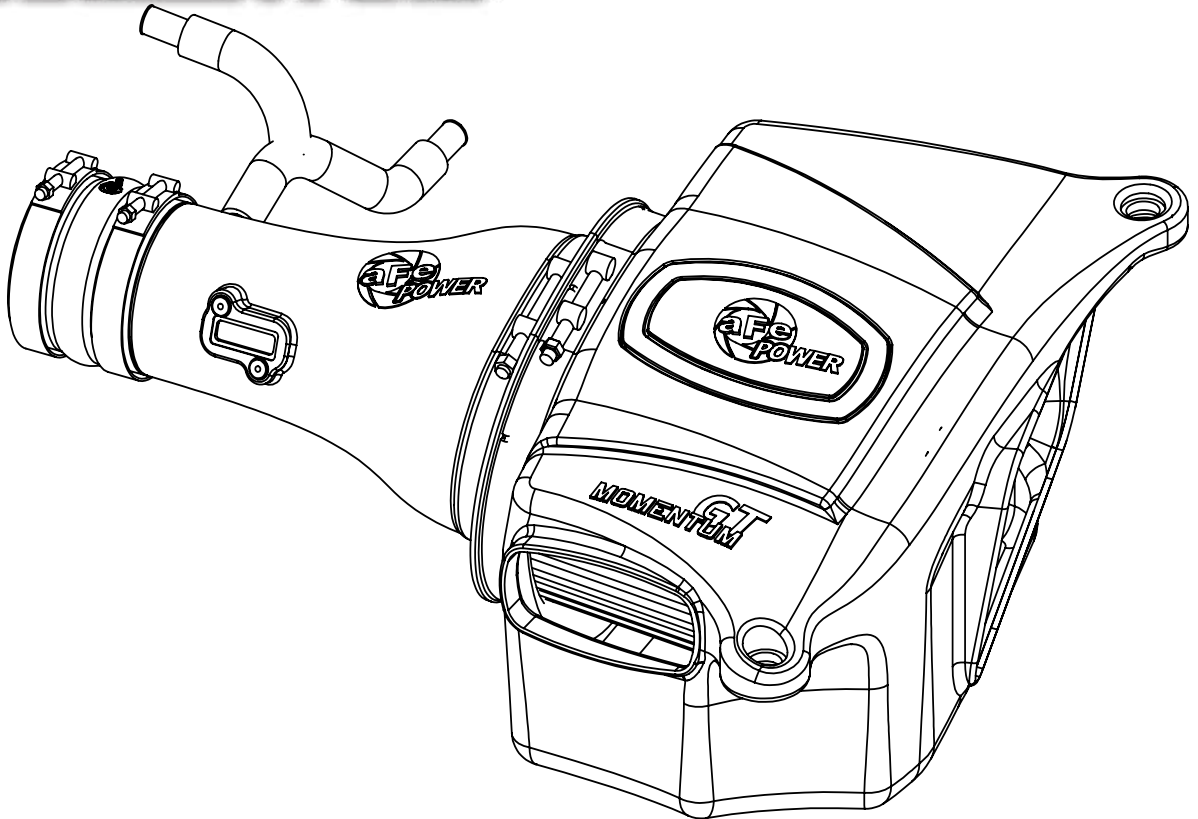

**advanced FLOW engineering** Momentum GT Cold Air Intake System

**Instruction Manual** P/N: 51-76103 / 54-76103 / 75-76103

Make: **Nissan** Model: **Patrol (Y62)** Year: **2010-2019** Engine: **V8-5.6L (400 HP)**

Make: **Nissan** Model: **Armada** Year: **2017-2019** Engine: **V8-5.6L**

Make: **Infiniti** Model: **QX56** Year: **2011-2013** Engine: **V8-5.6L**

Make: **Infiniti** Model: **QX80** Year: **2014-2019** Engine: **V8-5.6L**



- Please read the entire instruction manual before proceeding.
- Ensure all components listed are present.
- If you are missing any of the components, call customer support at 951-493-7100.
- Ensure you have all necessary tools before proceeding.
- Do not attempt to work on your vehicle when the engine is hot.
- Disconnect the negative battery terminal before proceeding.
- Retain factory parts for future use.

Label	Qty.	Description	Part Number
A1	1	Air Filter (Pro DRY S)	21-91061 (51-76103)
A2	1	Air Filter (Pro-5R)	24-91061 (54-76103)
A3	1	Air Filter (Pro GUARD 7)	72-91061 (75-76103)
B	1	Tube	05-76103B1
C	1	Housing	05-76103B2
D	1	Clamp, T-Bolt (8-5/16"-8-5/8") SS	03-50267
E	2	Clamp, T-bolt (3-9/16"-3-7/8") SS	03-50498
F	1	Coupling, Silicone Double Hump	05-01389
G	1	Hose, Adaptor CCv (Silicone)	05-01346
H	1	Plug, Urethane	05-01202
I	4	Ties, Nylon Cable, Black	05-60167

Tools needed: 7mm Nut Driver, 8mm Nut driver, 10mm Nut Driver, 11mm Deep Socket, 1/4" Ratchet, 10mm deep Socket, Flathead Screw Driver, Phillips Screw Driver, Pliers.

Recommended: Acetone

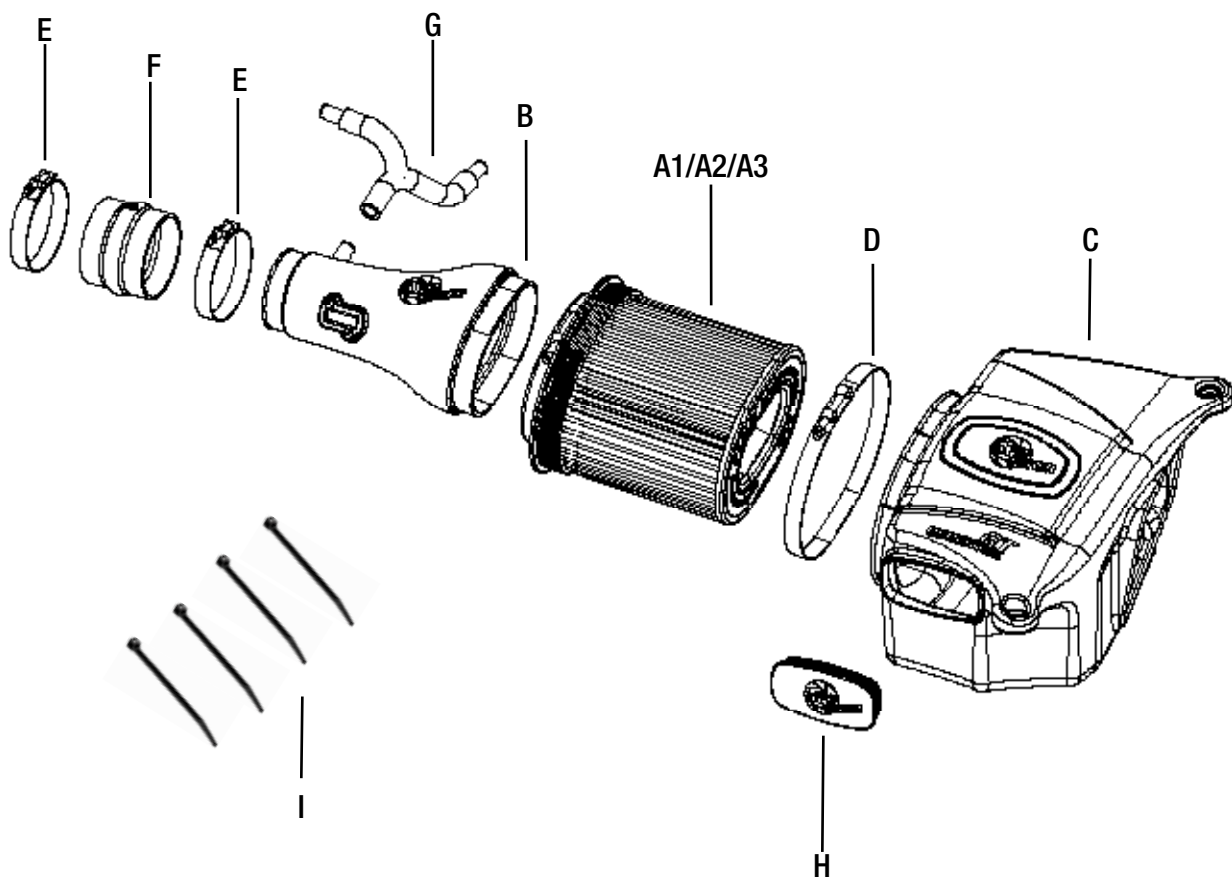



Figure A

**Refer to Figure A for Steps 1-2**

Step 1: Using a 10mm nut driver, remove the two bolts ① securing the engine cover.

Step 2: Lift and pull the engine cover toward you to remove.



Figure B

### **Refer to Figure B for Steps 3-7**

Step 3: Using an 8mm nut driver, loosen the hose clamp (2) at the throttle body.

Step 4: Using a 10mm nut driver, remove the three bolts (3) securing the OE housing in place.

Step 5: Unclip the Mass Air Flow (MAF) sensor (4) from tube.

Step 6: Using a 7mm nut driver or philips head screwdriver, remove both screws and MAF sensor.

You will reuse both screws.

Step 7: Carefully detach all three clips (5) securing the MAF sensor wiring harness to the OE housing.

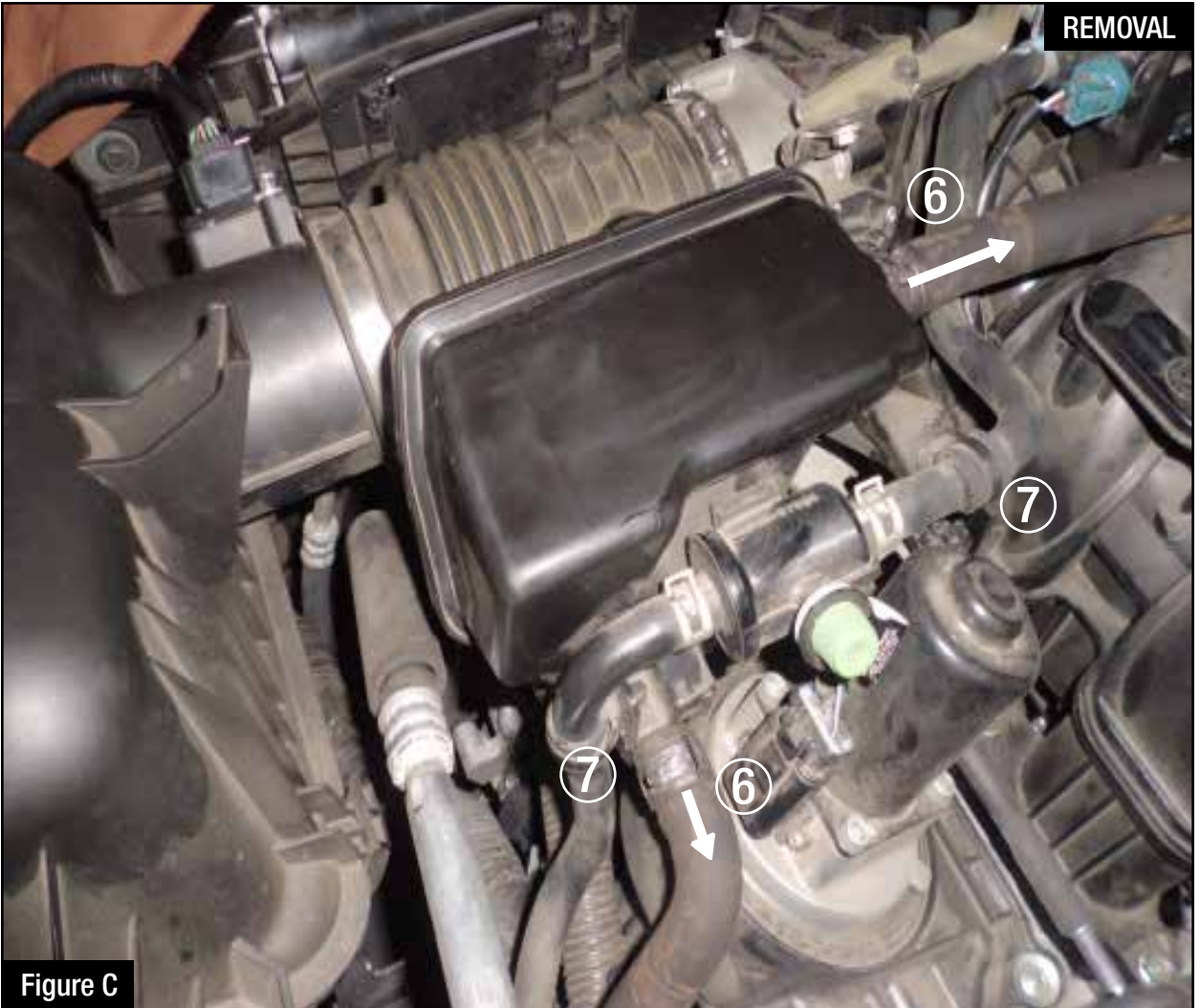
**Figure C****Refer to Figure C for Steps 8-11**

Step 8: Compress the metal spring clamps (6) on both crank case vent (CCV) hoses and slide down hose.

Step 9: Disconnect both CCV hoses from resonance chamber and position out of the way.

Step 10: Unclip and remove both plastic clips (7) connecting the rubber evap hose to the resonance chamber.

Step 11: Remove the entire OE intake assembly at this time.



Figure D

**Refer to Figure D for Steps 12-17**

Step 12: Slide large t-bolt clamp (8) over aFe housing flange as shown.

Step 13: Clean the inside of the rotomold housing flange and both mating surfaces of the filter flange (acetone recommended).

Step 14: Insert the filter into housing then the tube into the filter (9) and tighten both clamps at this time.

Step 15: Assemble the two smaller t-bolt clamps over the silicone hump coupler as shown (10).

Step 16: Tighten only the clamp over the tube side at this time (11).

Step 17: Insert MAF sensor (12) and secure using the two screws you removed in step 6.

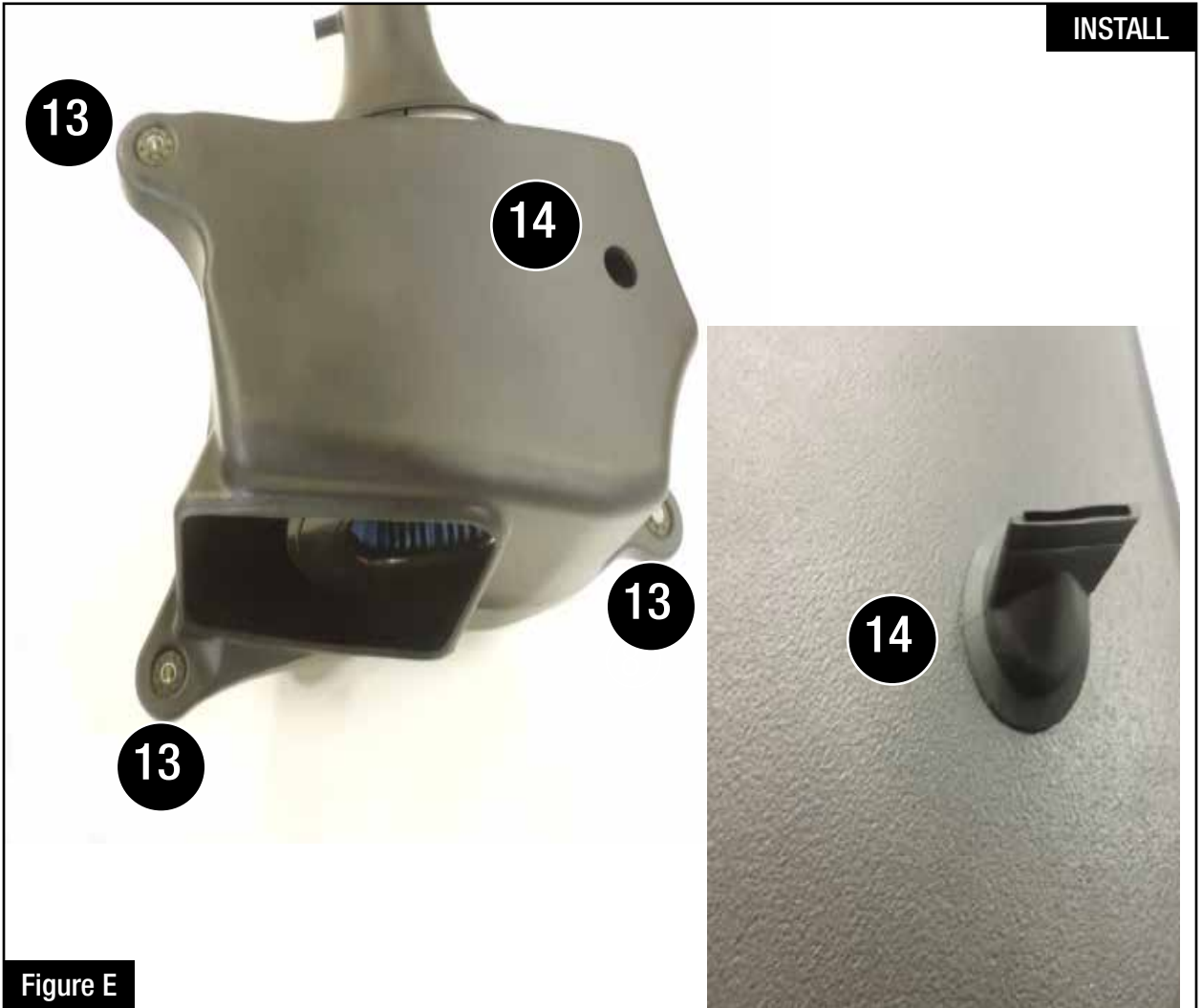

Figure E

**Refer to Figure E for Steps 18-19**

Step 18: Remove the 3 steel sleeves and rubber grommets (13) from the OE housing and install on the aFe housing as shown.

Step 19: If equipped with rubber duck-billed drain plug (14) install here, otherwise leave open.

**Figure F****Refer to Figure F for Steps 20-21**

Step 20: Take the full intake assembly and place silicone hump coupler over throttle body as shown.

Step 21: From the driver side of the engine, push and compress ⑮ the coupling while lowering the housing side down into position ⑯, aligning the three mounting locations.



**Refer to Figure G for Steps 22-25**

Step 22: Install (17) and tighten the three bolts you previously removed in step 4, securing the aFe housing in place.

Step 23: At this time, tighten the remaining t-bolt clamp (18) over the throttle body.

Step 24: If equipped with the vent hose shown in the inset picture, clip into the slot on the side of the aFe housing.

Step 25: Connect the MAF sensor to the aFe tube at this time (19).

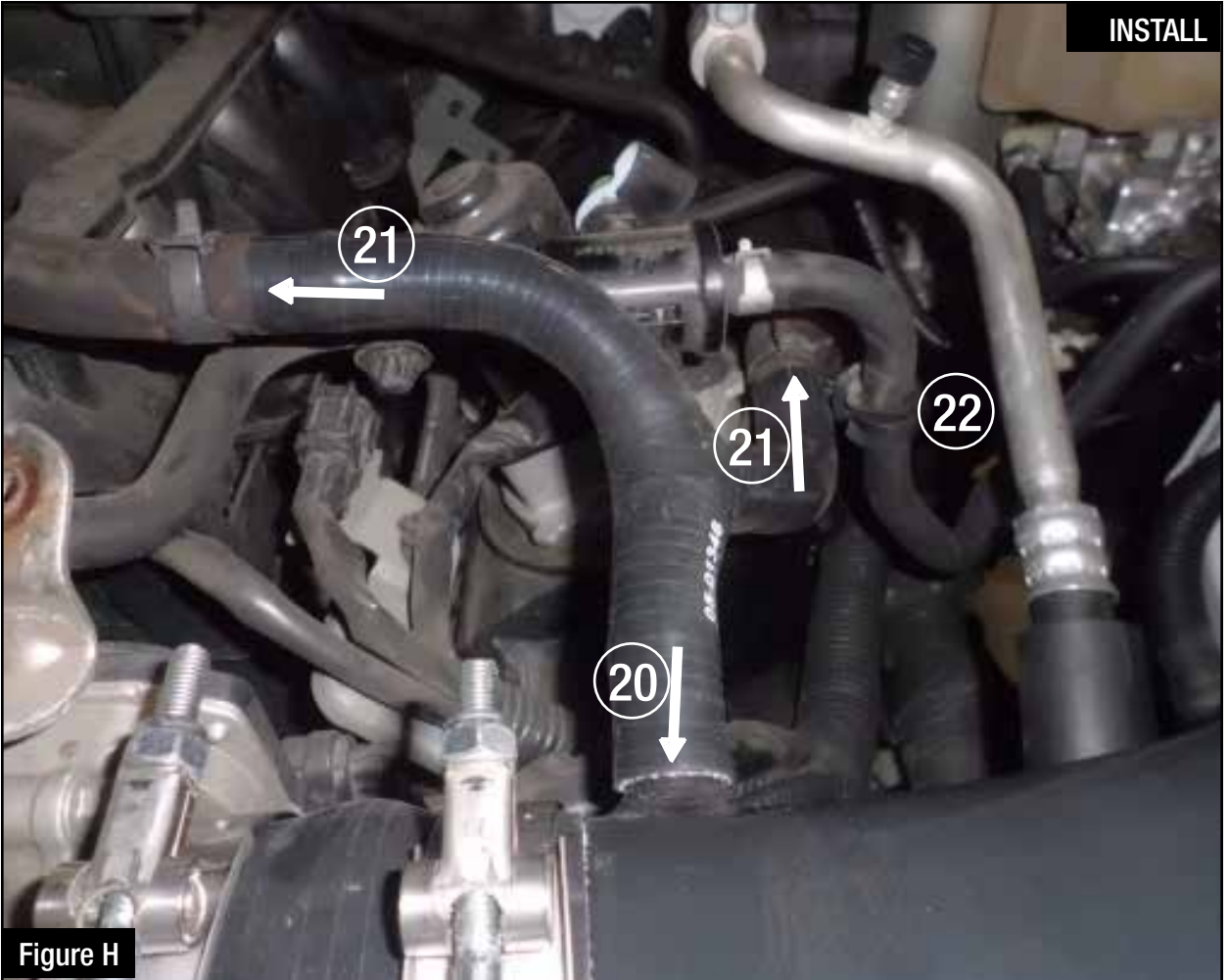
**Figure H****Refer to Figure H for Steps 26-29**

- Step 26: Install the provided silicone adaptor coupling: place the end with no metal fitting (20) over the nipple on the aFe tube.
- Step 27: Install the remaining two ends of the adaptor (21) with the stainless fittings into the CCV hoses.
- Step 28: Compress and slide the two spring clips over the silicone adaptor ends as shown.
- Step 29: Use a provided cable tie to secure (22) the evap hose to the silicone adaptor coupling.



INSTALL

Figure I

**Refer to Figure I for Steps 30-32**

Step 30: Using the provided cable ties, secure the MAF sensor wiring harness (23) as shown in the inset picture, in order to be neatly tucked out of the way.

Step 31: Make sure all clamps and connections are secured.

Step 32: Reinstall the engine cover at this time with the bolts you removed in Step 1.

Your installation is now complete. Thank you for choosing aFe Power!

**NOTE: Retighten all connections after approximately 100-200 miles. Place enclosed CARB EO sticker on or near the device on a smooth, clean surface. EO identification label is required to pass the smog inspection.**

Page left blank intentionally



Pro DRY S Air Filter

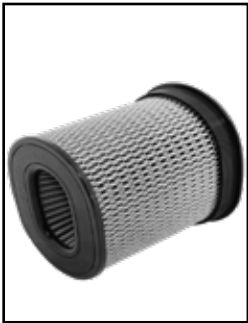

P/N: 21-91061

Pro 5R Air Filter



P/N: 24-91061

Pro-GUARD 7 Air filter



P/N: 72-91061

Pre-Filter



P/N: 28-10283

Pro DRY S Restore Kit



P/N: 90-59999

Blue Squeeze Restore Kit



P/N: 90-50501

Gold Squeeze Restore Kit



P/N: 90-50500

Throttle Body Spacer



P/N: 46-36004

To purchase any of the items above, view airflow charts, dyno graphs, photos, and video; please go to [aFepower.com](http://aFepower.com).

# Warranty

## General Terms:

- aFe warrants their products to be free from manufacturer's defects due to workmanship and material.
- This warranty applies only to the original purchaser of the product and is nontransferable.
- Proof of purchase of the aFe product is required for all warranty claims.
- Warranty is valid provided aFe instructions for installation and/or cleaning were properly followed.
- Proper maintenance with regular inspections of product is required to insure warranty coverage.
- Damage due to improper installation, abuse, unauthorized repair or alteration is not warranted.
- Incidental or consequential damages or cost, including installation and removal of part, incurred due to failure of aFe product is not covered under this warranty.
- All warranty is limited to the repair and/or replacement of the aFe part. To request Return Goods Authorization ("RGA"), email [RGA@afepower.com](mailto:RGA@afepower.com) or call (951)493-7100. Upon receipt of the RGA, you must return the product to the address provided in the RGA, freight prepaid and accompanied with a dated proof of purchase and the RGA. Upon receipt of the defective product and upon verification of proof of purchase, aFe will either repair or replace the defective product within a reasonable time, not to exceed thirty days.

<b>Product Category</b>	<b>P/N Prefix</b>	<b>Warranty duration</b>
Direct OE Replacement Filters	10, 11, 30, 31, 71, 73	Life of the vehicle
Racing Filters	18	1 year
Universal	21, 24, 72	2 years
Air Intake Systems	50, 51, 54, 55, 75	2 years
Exhaust Systems	49	2 years
Intercoolers & Intercooler Tubes	46-2	2 years
Intake Manifolds	46-1	2 years
Differential Cover	46-7	Life of the vehicle
Exhaust Manifolds	46	2 years
Throttle Body Spacers	46-3	2 years
Fluid Filters	44	90 days
Pre-Filters	28	2 years
Heavy Duty OE Replacement	70	2 years
PowerSports OE Replacement	81, 87	2 years
PowerSports Intake Systems	85	2 years

No other warranty expressed or implied applies nor is any person or advanced FLOW engineering authorized to assume any other warranty. Some States do not allow the exclusion or limitation of incidental or consequential damages or do not allow limitations on how long an implied warranty lasts, so the above limitations or exclusions may not apply to you. This warranty gives you specific legal rights, and you may also have other rights which vary from State to State.

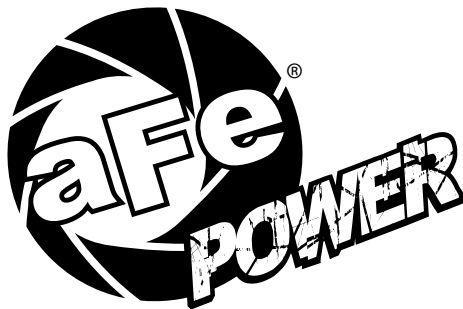

**advanced FLOW engineering, inc.**  
252 Granite Street Corona, CA 92879  
TEL: 951.493.7100 • TECH: 951.493.7134  
E-Mail: [Tech@aFepower.com](mailto:Tech@aFepower.com)