

MOMENTUM **HD**

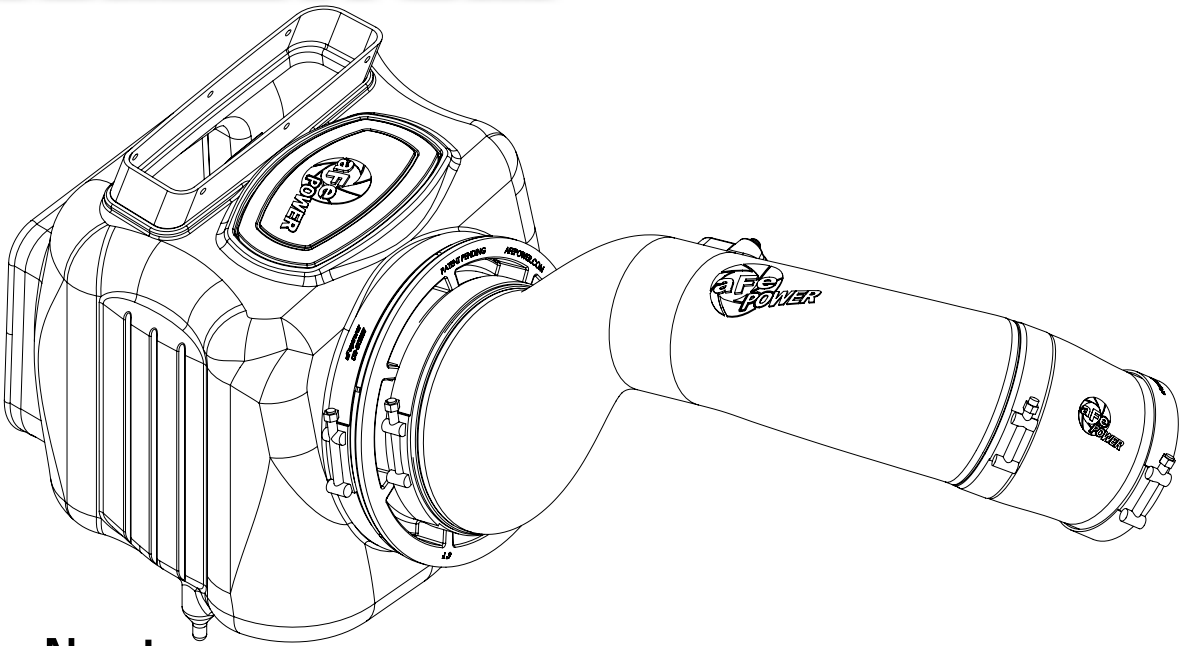

The Next
Generation
of Intakes
advanced FLOW engineering

Instruction Manual P/N: 50-74008 / 51-74008

Make: **Chevrolet** Model: **Silverado HD** Year: **2017-2019** Engine: **V8-6.6L Duramax (L5P)**
Make: **GMC** Model: **Sierra HD** Year: **2017-2019** Engine: **V8-6.6L Duramax (L5P)**
Note: **Includes Denali Models.**



- Please read the entire instruction manual before proceeding.
- Ensure all components listed are present.
- If you are missing any of the components, call customer support at 951-493-7100.
- Ensure you have all necessary tools before proceeding.
- Do not attempt to work on your vehicle when the engine is hot.
- Disconnect the negative battery terminal before proceeding.
- Retain factory parts for future use.

Label	Qty.	Description	Part Number
A1	1	Pro DRY S Air Filter	21-91059
A2	1	Pro 10R Air Filter	20-91059
B	1	Tube	05-74008B1
C	1	Housing	05-74008B2
D	1	Scoop	05-74008B3
E	1	Clamp, T-bolt (8-5/16" - 8-5/8")	03-50267
F	1	Coupling, Silicone Elbow	05-01420
G	1	Clamp, T-bolt (4-5/16" - 4-5/8")	03-50499
H	1	Seal Trim 7/16" (27" Inches)	05-00072
I	2	Screws, Torx M4	03-50491
J	1	Clamp, T-bolt (4-1/16" - 4-3/8")	03-50262

Installation will require the following tools:

8mm Nut driver, 11mm Nut driver, T20 torx bit or driver, 13mm deep socket, extension and driver.

Warranty Information available at: <https://afepower.com/contact#warranty>

Note: Legal in California for use on race vehicles only. The use of this device on vehicles used on public streets or highways is strictly prohibited in California and others states that have adopted California emission regulations.

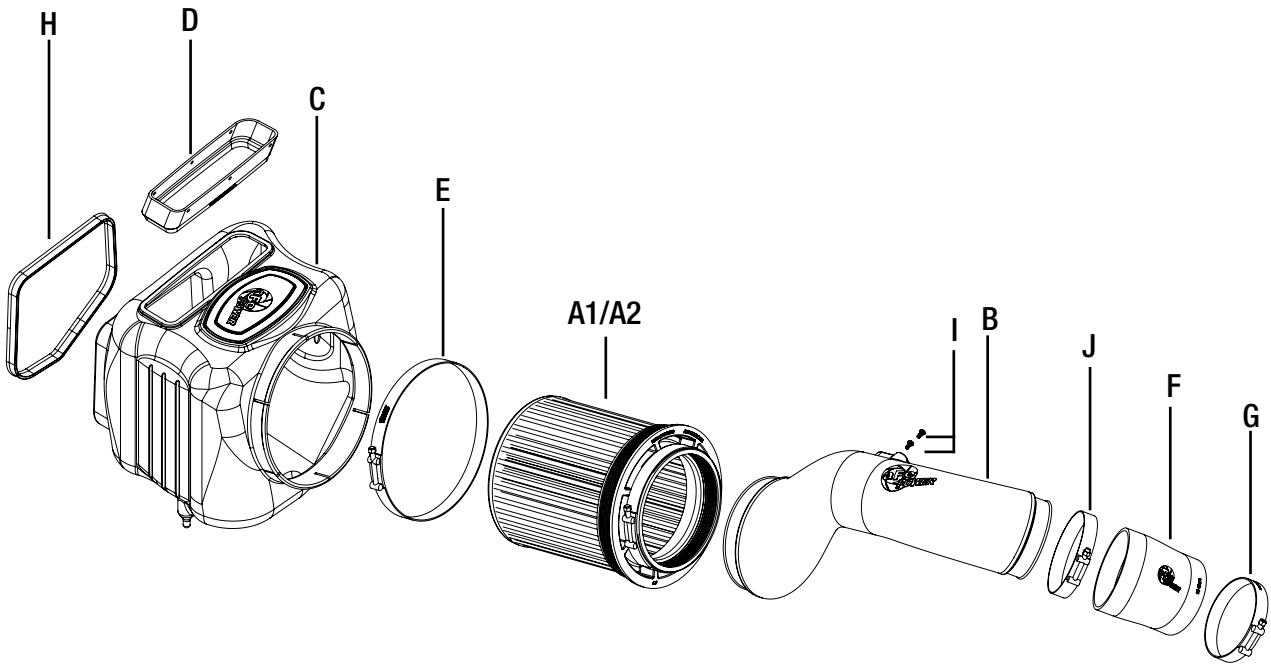



Refer to Figure A for Steps 1-2

Step 1: Disconnect the MAF sensor plug. ①

Step 2: Disconnect the MAF sensor harness clip ② from the OE airbox.

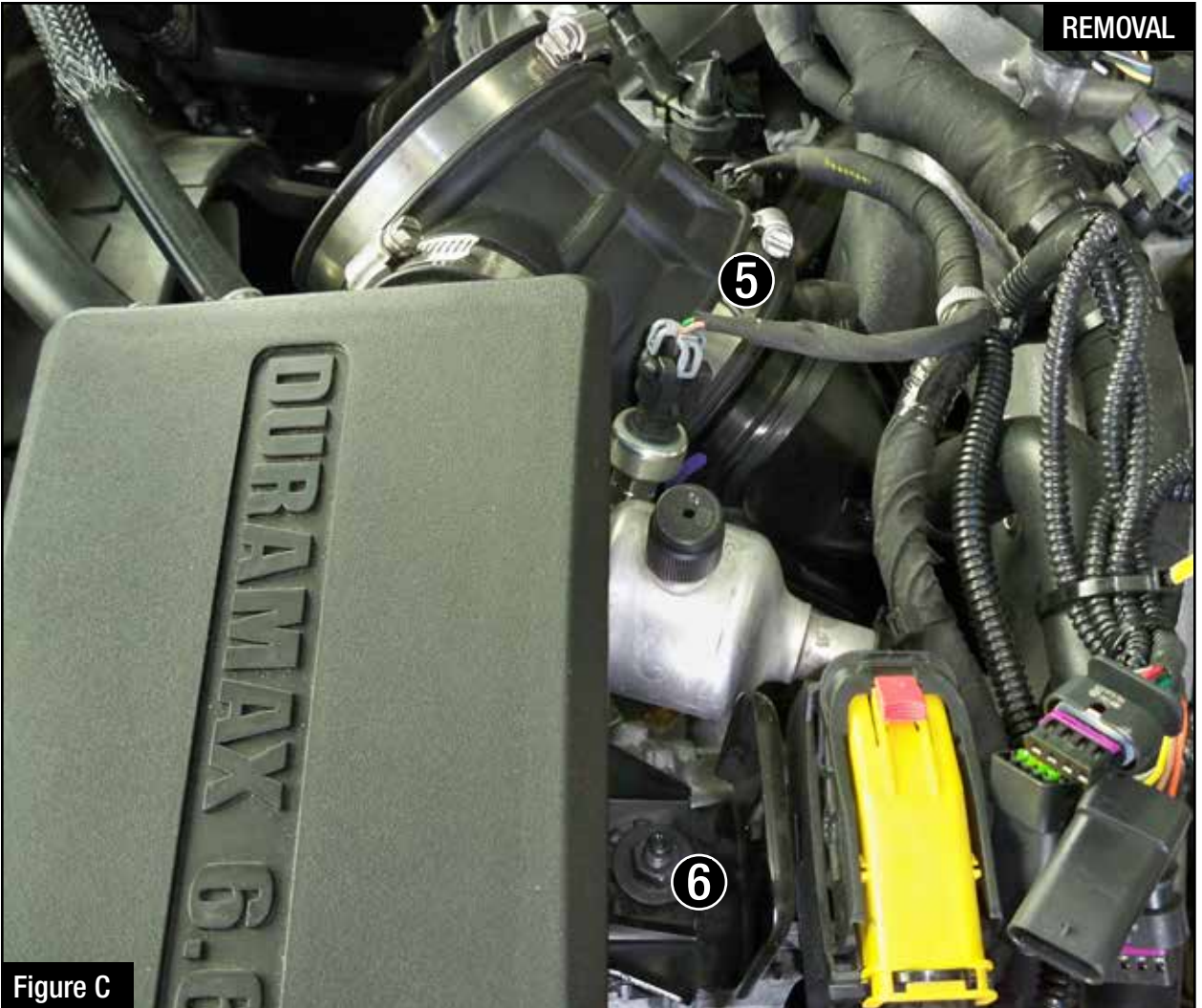

Figure B

Refer to Figure B for Steps 3-4

Step 3: Loosen the clamps (3) at the airbox and at the resonator coupler.

Step 4: Remove the stock intake tube. (4)

**Figure C****Refer to Figure C for Step 5**

Step 5: If you wish to remove the resonator, loosen the clamp (5) at the turbo inlet with an 8mm nut driver. Using a 13mm deep socket, extension and driver, remove the nut (6) holding the resonator. Remove the resonator with the stock coupler.

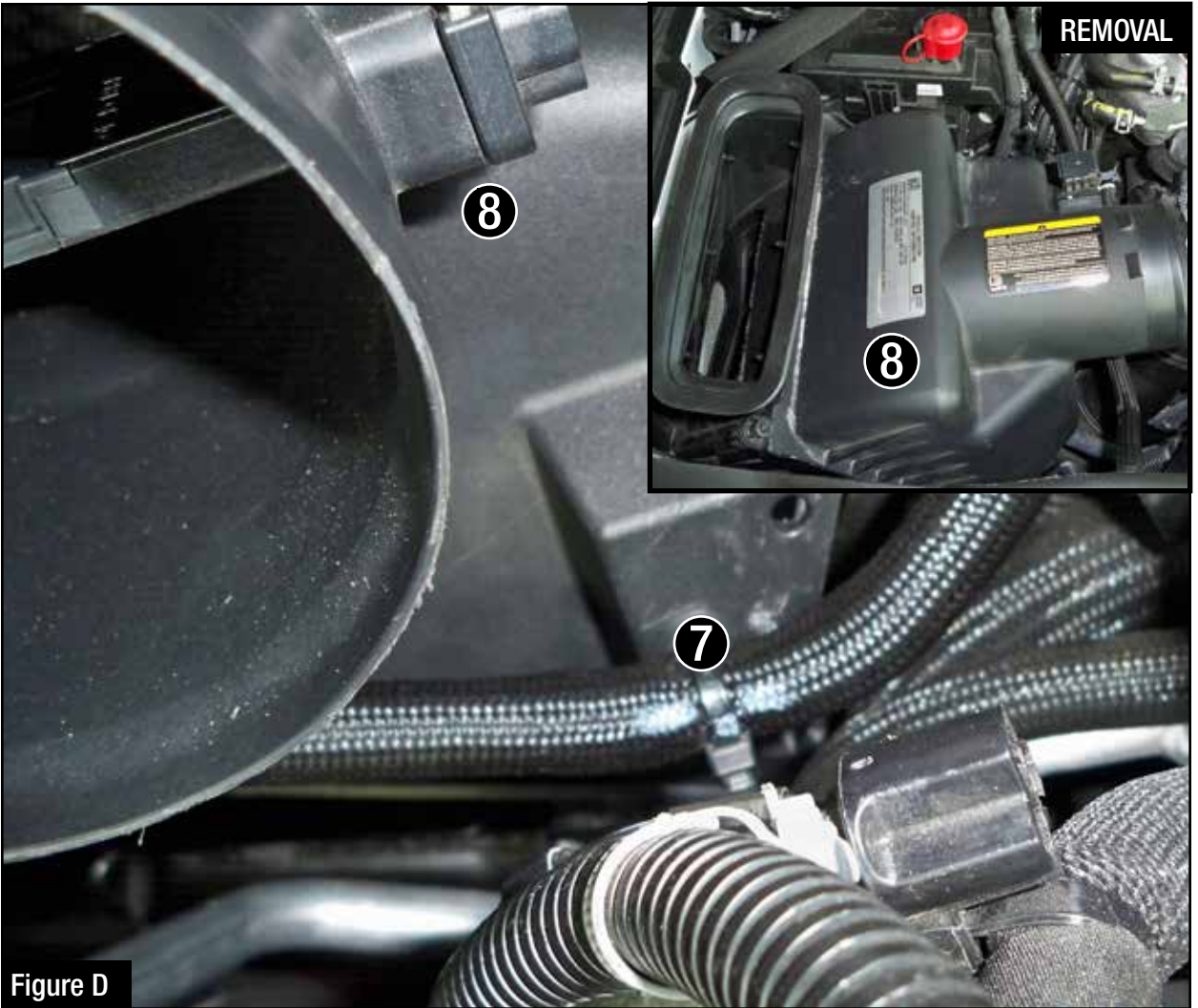
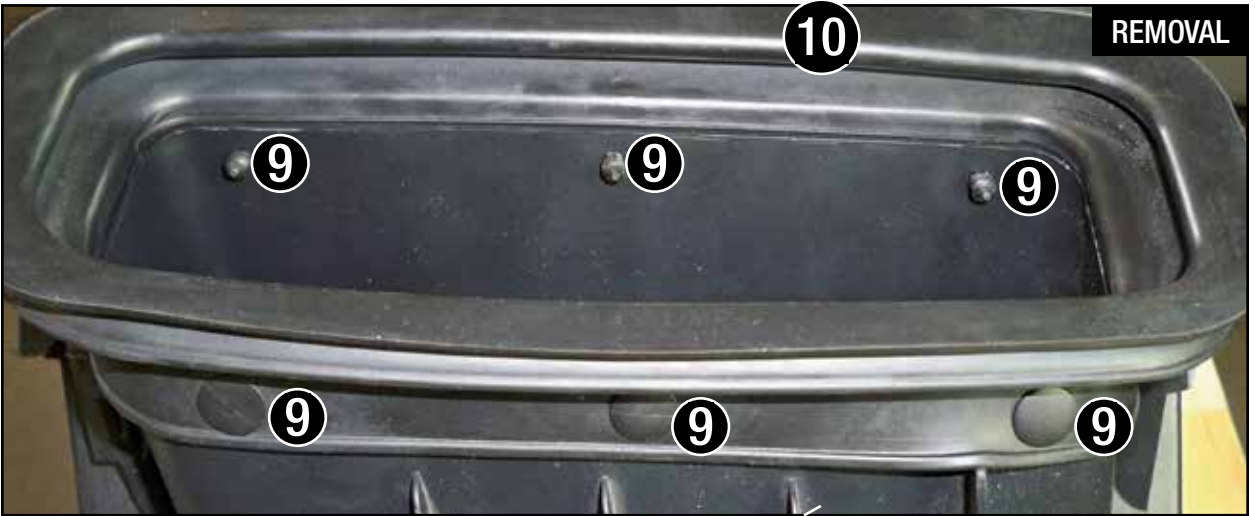

Figure D

Refer to Figure D for Step 6

Step 6: Remove the coolant line clip (7) from the airbox then remove the factory airbox (8) out of the vehicle. (Use an upward pull to release the retaining plug).



Refer to Figure E for Step 7

Step 7: Remove the 6 clips (9) holding the rubber seal (10) on the stock airbox. Remove the rubber seal and transfer it to the aFe airbox scoop (11). Reuse the 6 clips to attach the rubber seal to the scoop.



Figure F

Refer to Figure F for Steps 8-9

Step 8: Remove the retaining plug (12) from the bottom of the factory airbox and transfer it to the aFe airbox.

Step 9: Install the trim seal (13) on the opening of the aFe airbox.



Figure G

Refer to Figure G for Step 10

Step 10: Install the supplied large clamp (14) on the airbox then Slide the aFe filter and clamp (15) into the airbox. Do not tighten the clamps at this time.



Figure H

Refer to Figure H for Step 11

Step 11: Install the aFe airbox assembly into the vehicle. Firmly push it into the factory mounting grommets.

REMOVAL

INSTALL



Figure I

Refer to Figure I for Steps 12-13

Step 12: Remove the MAF sensor with gasket (16) from the factory airbox using a T20 Torx drive.

Step 13: Install the MAF sensor with gasket into the aFe intake tube using the supplied M4 screws and a T20 Torx drive.

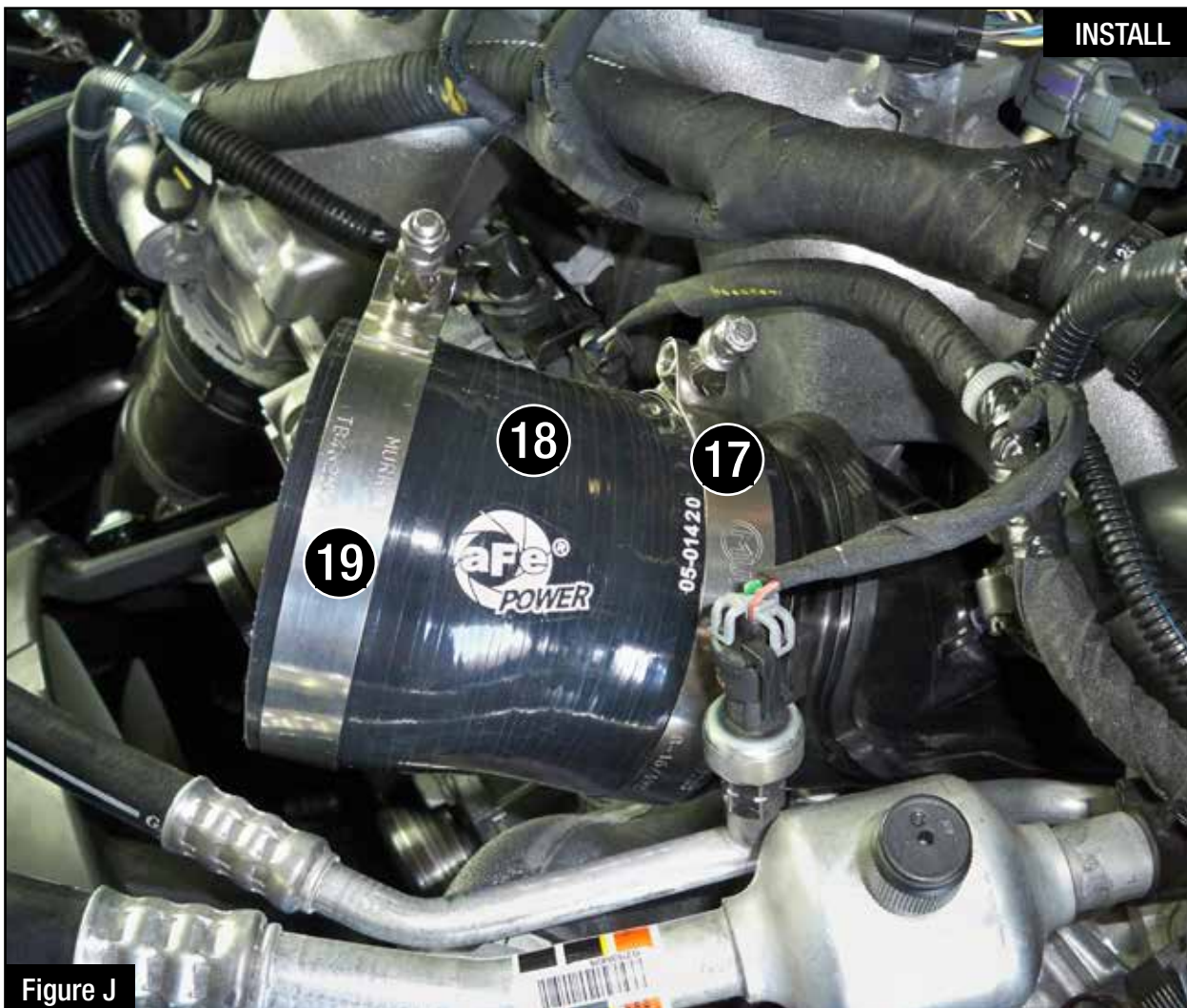

Figure J

Refer to Figure J for Step 14

Step 14: If the resonator is removed, install the supplied small clamp (17), coupler (18) and large clamp. (19)



Figure K

Refer to Figure K for Steps 15-16

Step 15: Slide the intake tube into the filter and then into the coupler.

Step 16: Align the intake tube correctly then tighten all clamps.



Figure L

Refer to Figure L for Steps 17-19

Step 17: Install scoop with the rubber seal (20) on top of the airbox.

Step 18: Reconnect the MAF sensor harness. (21)

Step 19: Make sure all clamps and connections are secured. Your installation is now complete! Thank you for choosing aFe POWER.

NOTE: Check all bolts, clamps, and connectors after 200 miles.

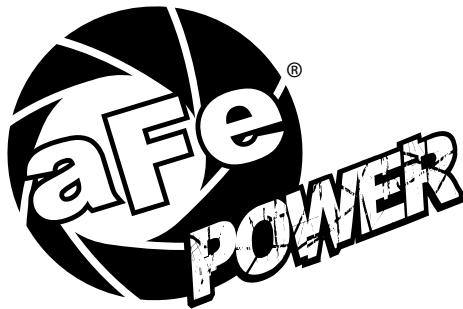

advanced FLOW engineering, inc.
252 Granite Street Corona, CA 92879
TEL: 951.493.7100 • TECH: 951.493.7134
E-Mail: Tech@aFepower.com