

***advanced FLOW engineering***

Takeda Momentum Cold Air Intake System

**Instruction Manual** P/N: 56-70031D / 56-70031R

Make: Toyota

Model: Corolla

Year: 2019-2021

Engine: L4-2.0L



- Please read the entire instruction manual before proceeding.
- Ensure all components listed are present.
- If you are missing any of the components, call customer support at 951-493-7185.
- Ensure you have all necessary tools before proceeding.
- Do not attempt to work on your vehicle when the engine is hot.
- Retain factory parts for future use.

Label	Qty.	Description	Part Number
A1	1	Air Filter (Pro 5R)	24-91103
A2	1	Air Filter (Pro DRY S)	21-91103
B	1	Tube	05-5670031B1
C	1	Housing	05-5670031B2
D	1	Coupling, Silicone Bellow: (2.75" x 3") ID x 25 Degree	05-01558
E	1	Clamp, 044 (2-5/16" - 3-1/4")	03-50019
F	1	Clamp, 052 (2-13/16" - 3-3/4")	03-50008
G	1	Fitting, Elbow	03-50165
H	2	Screw, Torx M4	03-50491
I	1	Plug, Silicone	05-01527
J	1	Sleeve, Silicone: 56-70031	05-01569
K	1	Hose, Silicone: 5/8" ID (10")	05-01502

**Installation will require the following tools:**

T-20 Torx driver, #2 Phillips screwdriver, 8mm nut driver, 10mm nut driver, and needle-nose pliers.

**Emissions Disclaimer:** This product is not currently CARB exempt and is not available for purchase in California or for use on any vehicle registered with the California Department of Motor Vehicles.

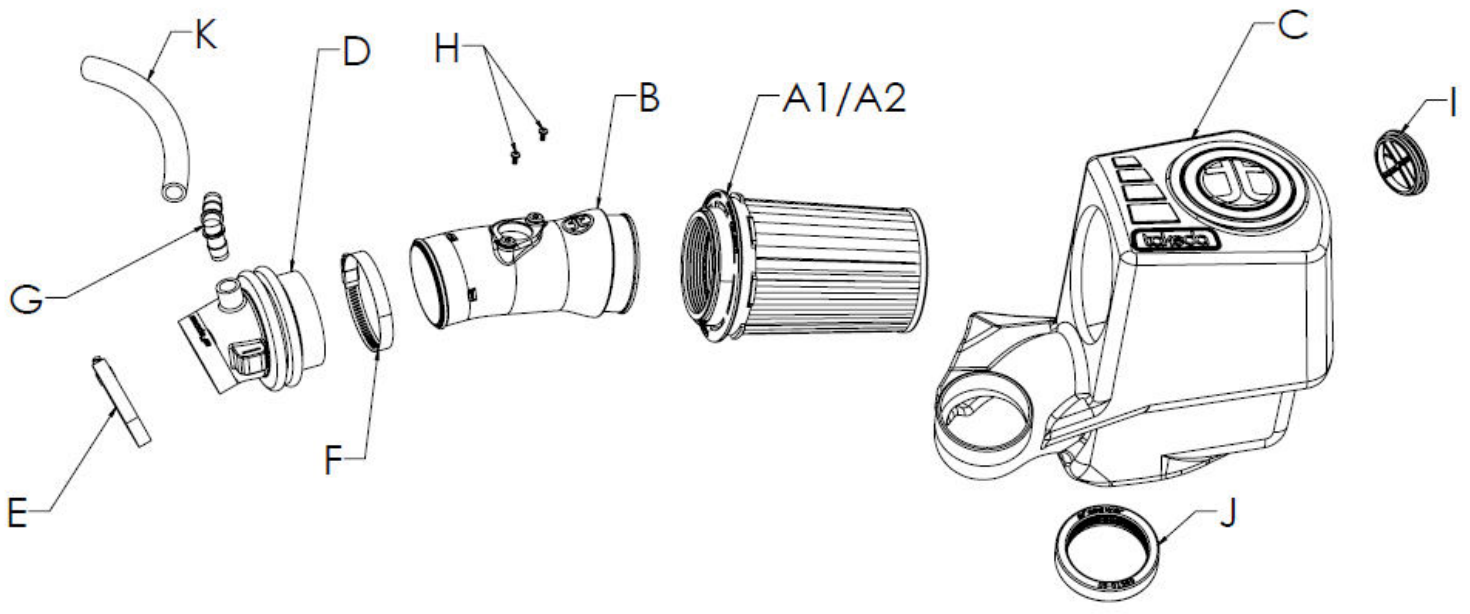

**Figure A****Refer to Figure A for Step 1**

Step 1: Remove front cover by removing the 8 push-clips. Remove the push clip by pushing the center button in, and then pulling up the whole clip out of the cover. Save all the hardware for reinstallation.

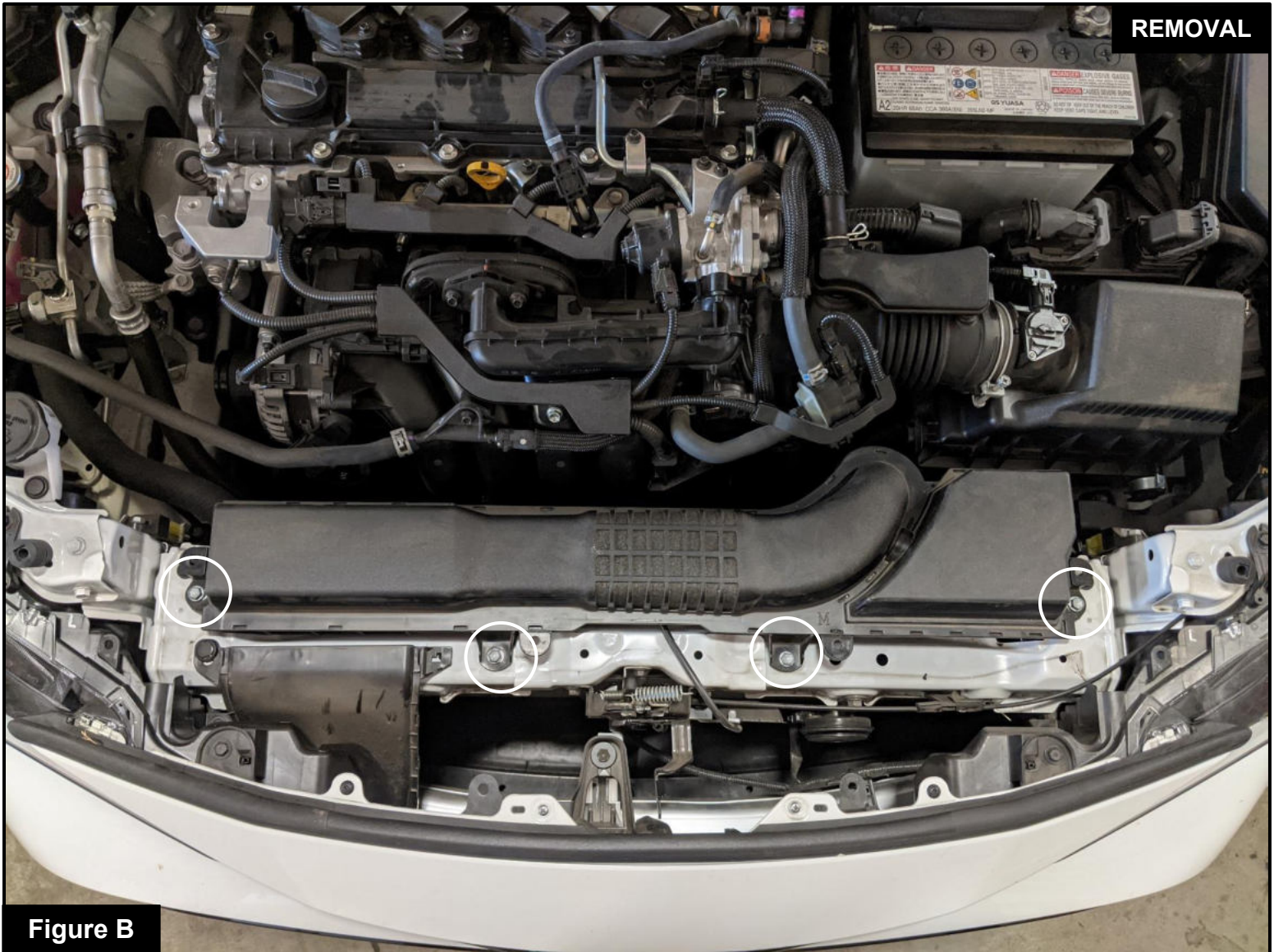
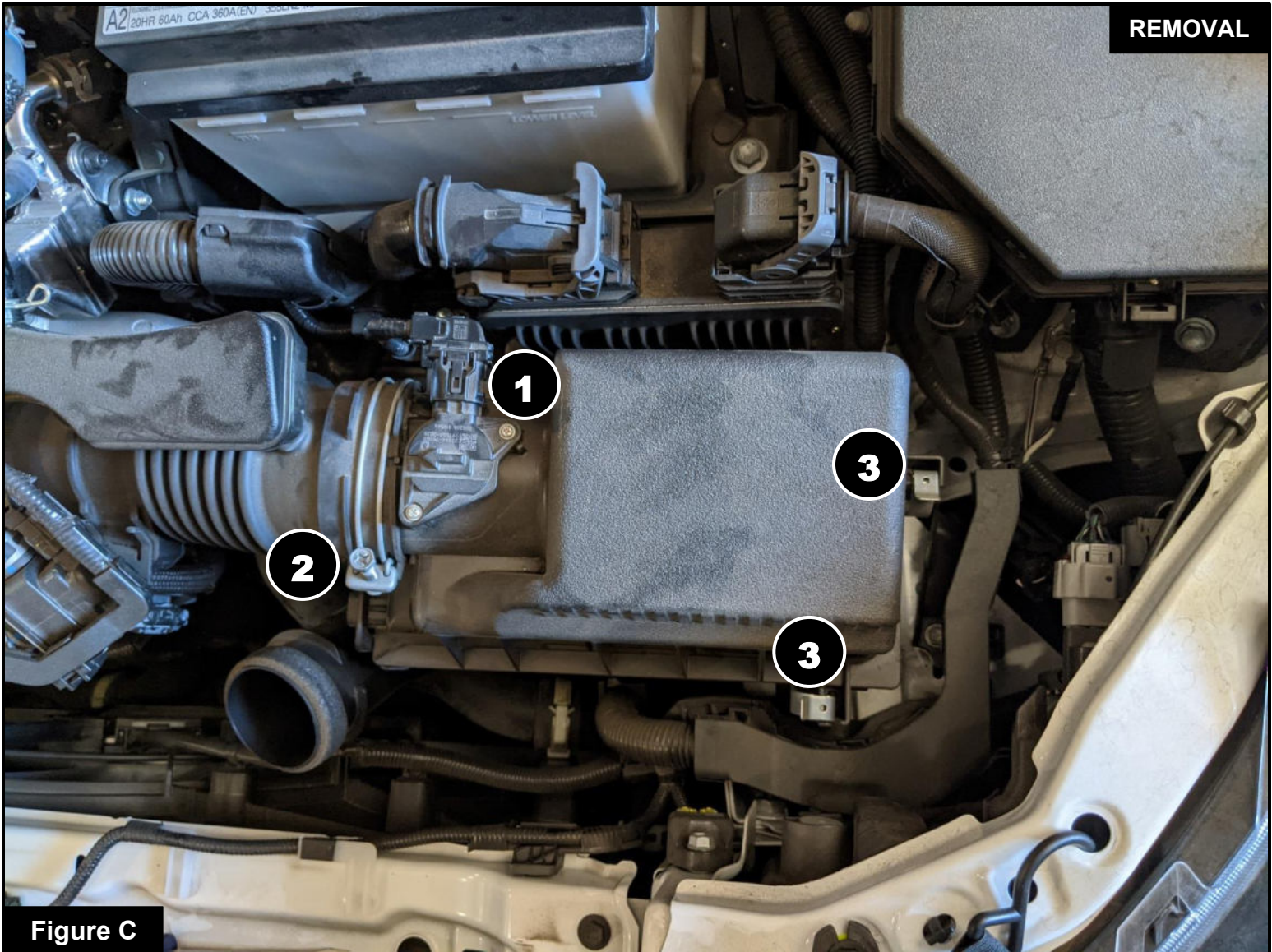

Figure B

**Refer to Figure B for Step 2**

Step 2: Remove the air inlet by removing the 4 bolts with a 10mm nut driver. These bolts will be re-used for reinstallation of the air inlet.



### **Refer to Figure C for Steps 3-6**

Step 3: Unclip the wiring harness plug (1) from the Mass Air Flow (MAF) sensor.

Step 4: Remove the MAF Sensor from the housing cover by removing the two screws securing it with a Phillips screwdriver. The MAF sensor will be installed on the Takeda Tube with two provided screws.

Step 5: Loosen the clamp on the intake tube using a 10mm nut driver (2).

Step 6: Unhook the two latches on the top of the housing (3) and slip the housing top out of the tube.

**Figure D****Refer to Figure D for Step 7**

Step 7: Remove the harness from the housing cover completely by squeezing the two tabs together and pushing it out through the mount.

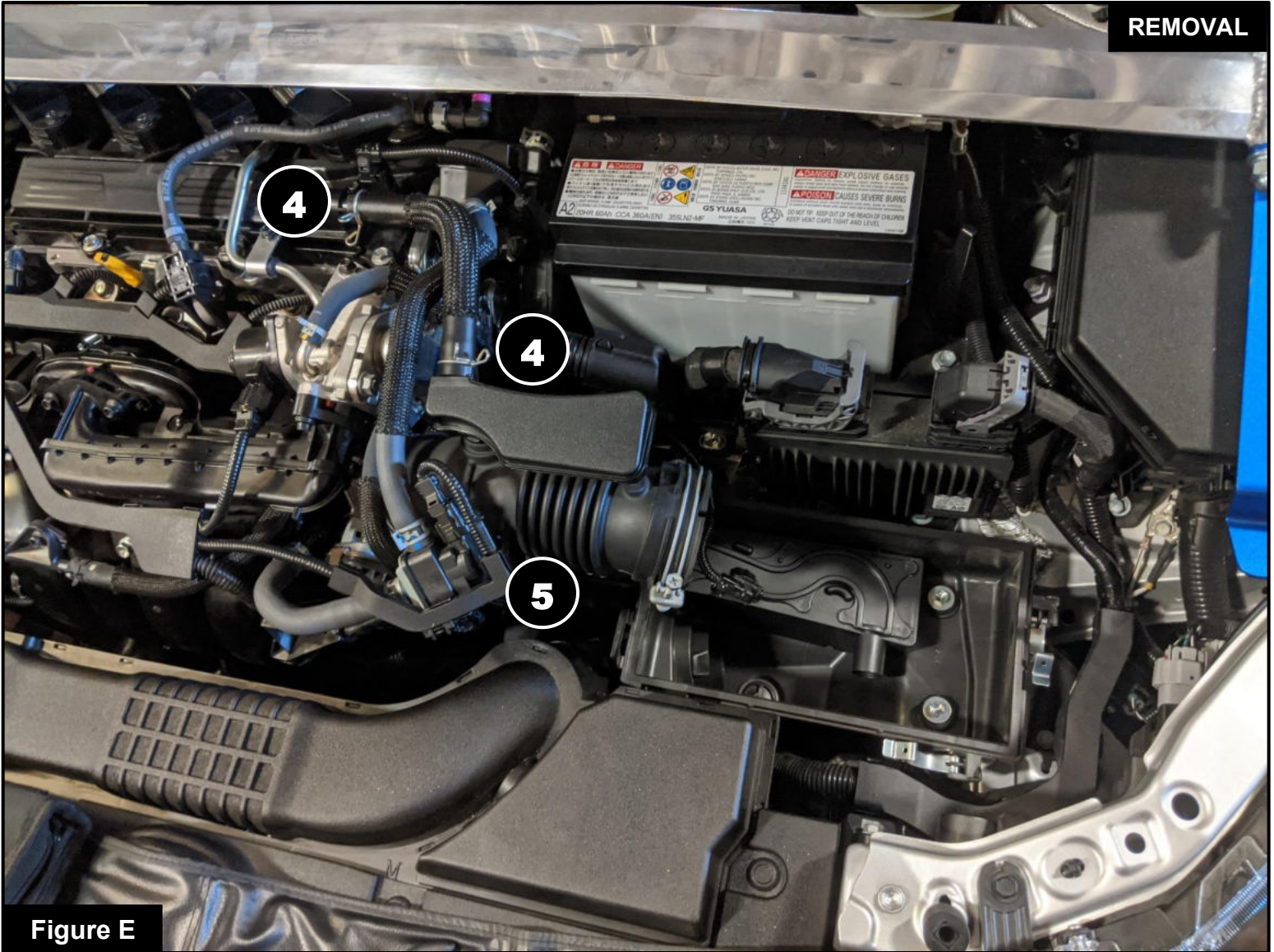
**Figure E**

**Refer to Figure E for Steps 8-10**

Step 8: Remove the PCV hose (4) from the intake tube and valve cover. Keep the hose clamps for installation of the Takeda tube and the provided replacement hose.

Step 9: Remove the intake tube by loosening the hose clamp on the throttle body using a 10mm nut driver.

Step 10: Remove the EVAP Solenoid assembly by pulling the bracket out of the pocket on the intake tube. (5)

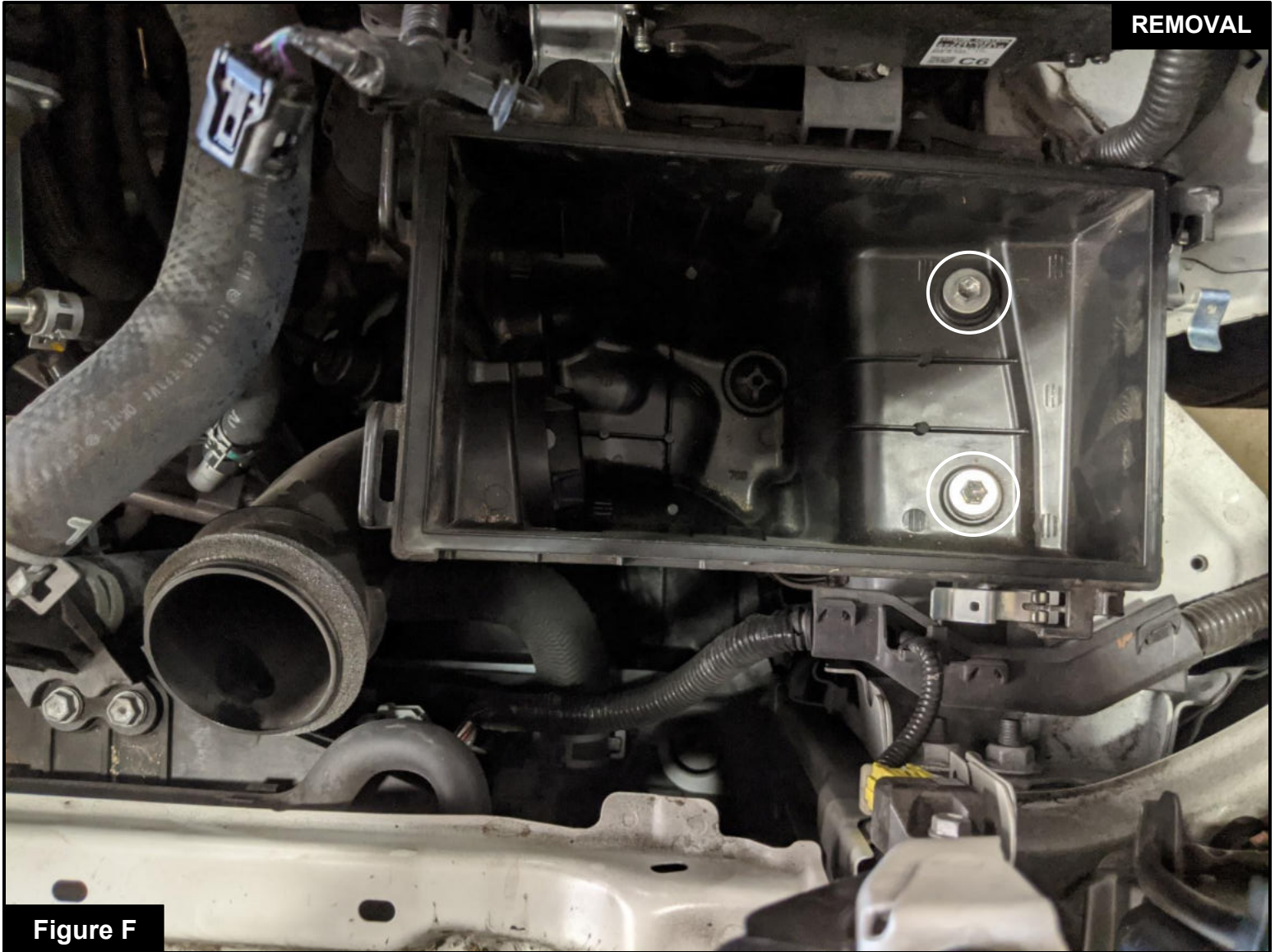

Figure F

**Refer to Figure F for Step 11**

Step 11: Remove the housing from the vehicle by removing the two bolts with a 10mm nut driver. Keep these bolts for installation of the Takeda housing.

**Figure G****Refer to Figure G for Step 12**

Step 12: Remove the two grommets and sleeves from the bottom of the factory housing and insert them into the Takeda housing, as shown.



### **Refer to Figure H for Step 13**

Step 13: Install the Takeda housing into the engine bay, ensuring the mounting peg lines up with the mount. Secure the housing to the engine bay by using the screws removed in Step 11.



Figure I

**Refer to Figure I for Step 14**

Step 14: Install the air filter into the housing by firmly pushing it into the housing until the filter tabs lock it into place. Install on the clamp on the filter, but do not tighten at this time.

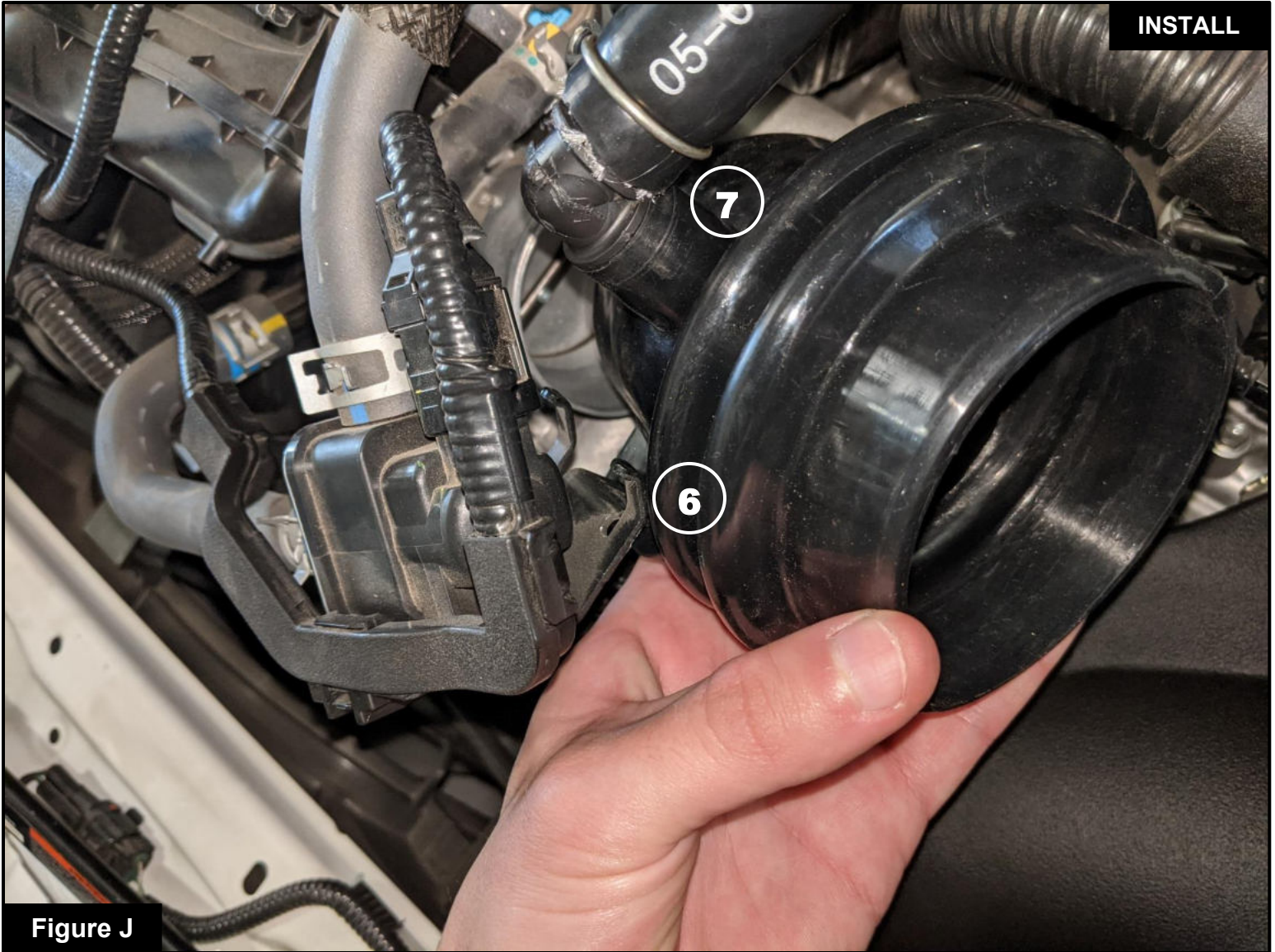
**Figure J****Refer to Figure J for Steps 15-16**

Step 15: Insert the EVAP solenoid assembly bracket into the slot on the coupling until it is full seated. ⑥

Step 16: Insert the furnished 90 degree fitting into the coupling. Secure the included black hose to the fitting using one of the factory hose clamps removed from Step 8. ⑦

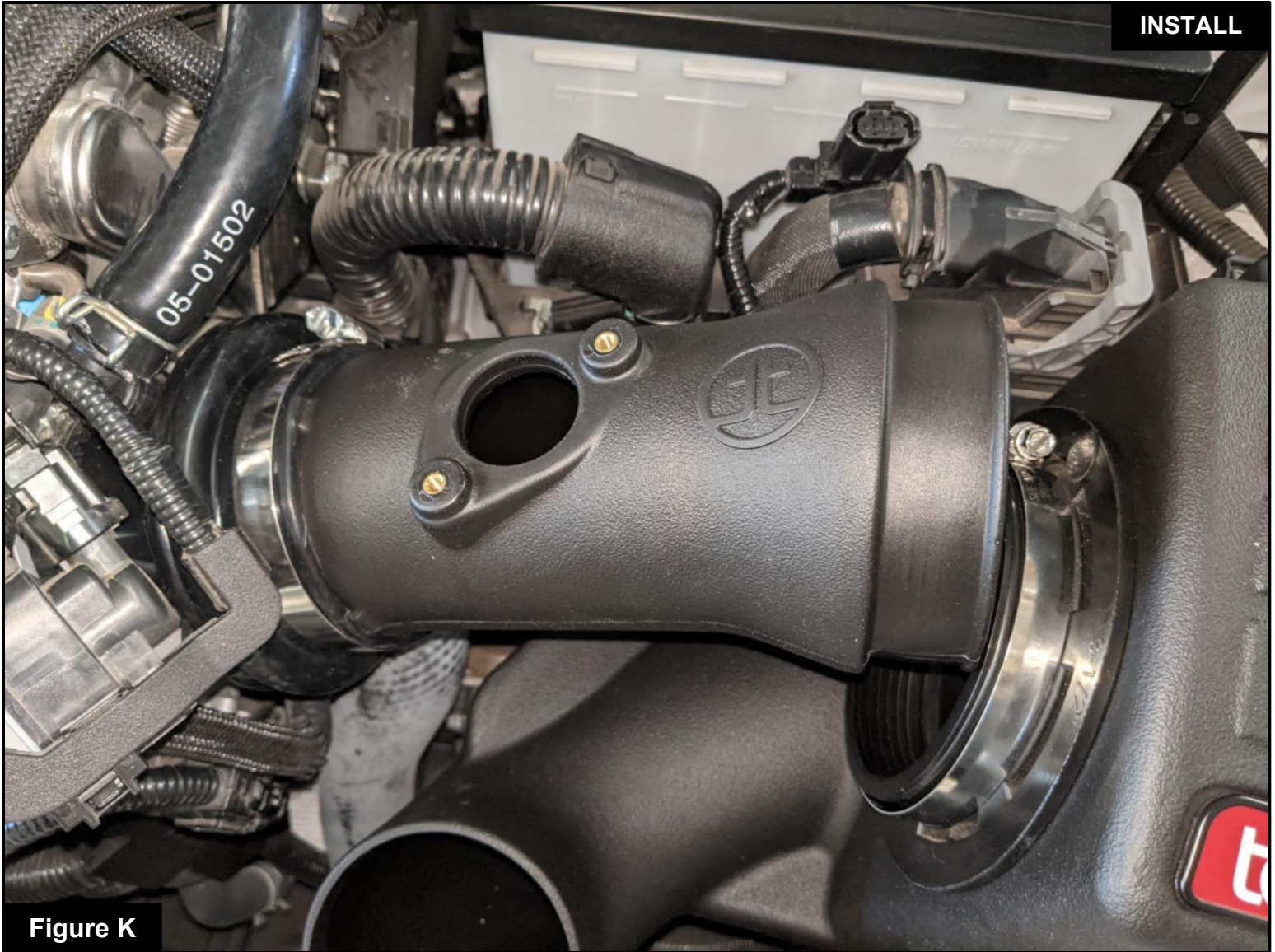
**Figure K****Refer to Figure K for Steps 17-18**

Step 17: Slide the coupling and the smaller #44 clamp onto the throttle body. Do not fully tighten the coupling at this time.

Step 18: Insert the tube into the coupling with the #52 clamp as shown. Do not fully tighten the coupling at this time.

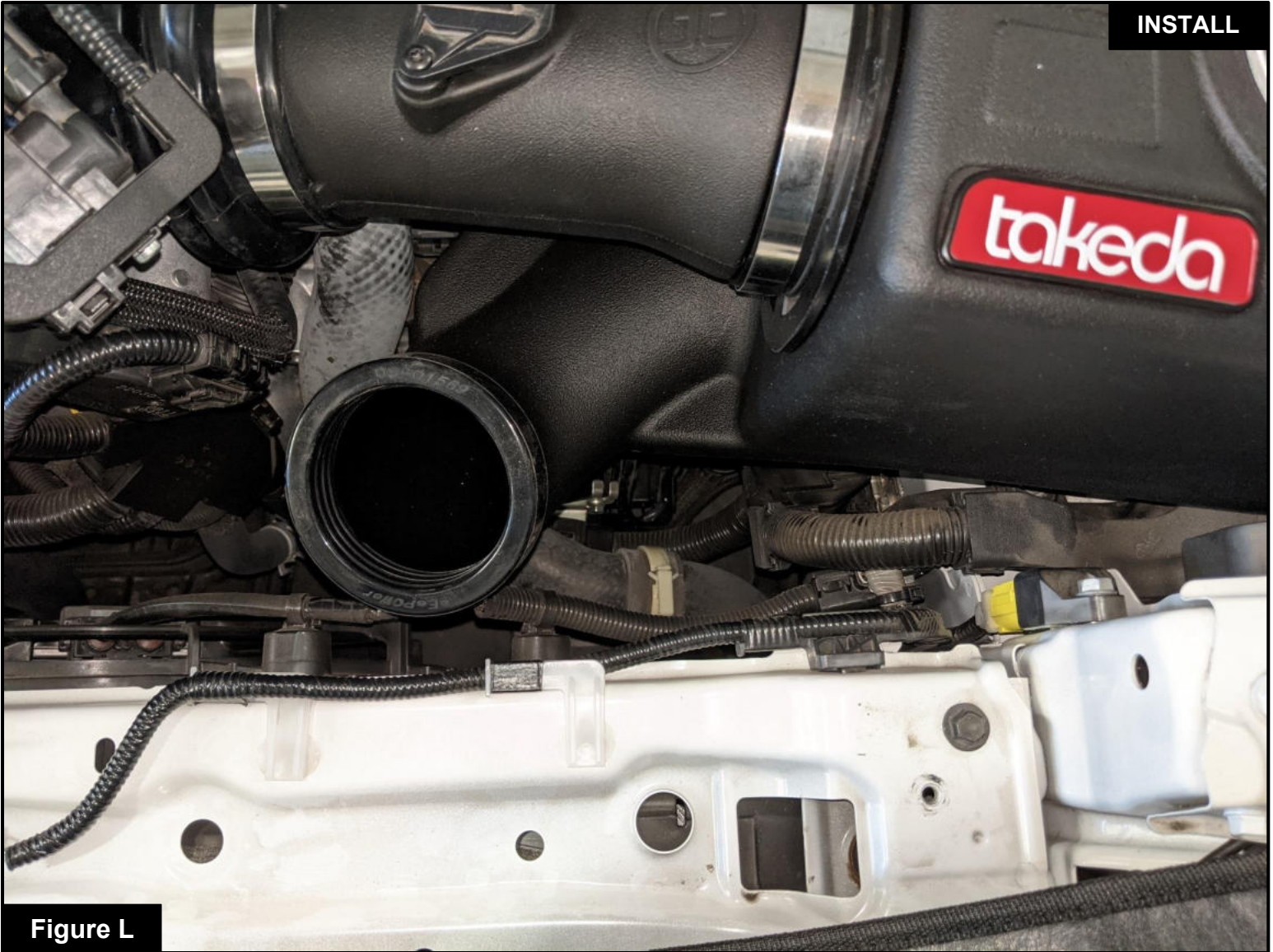
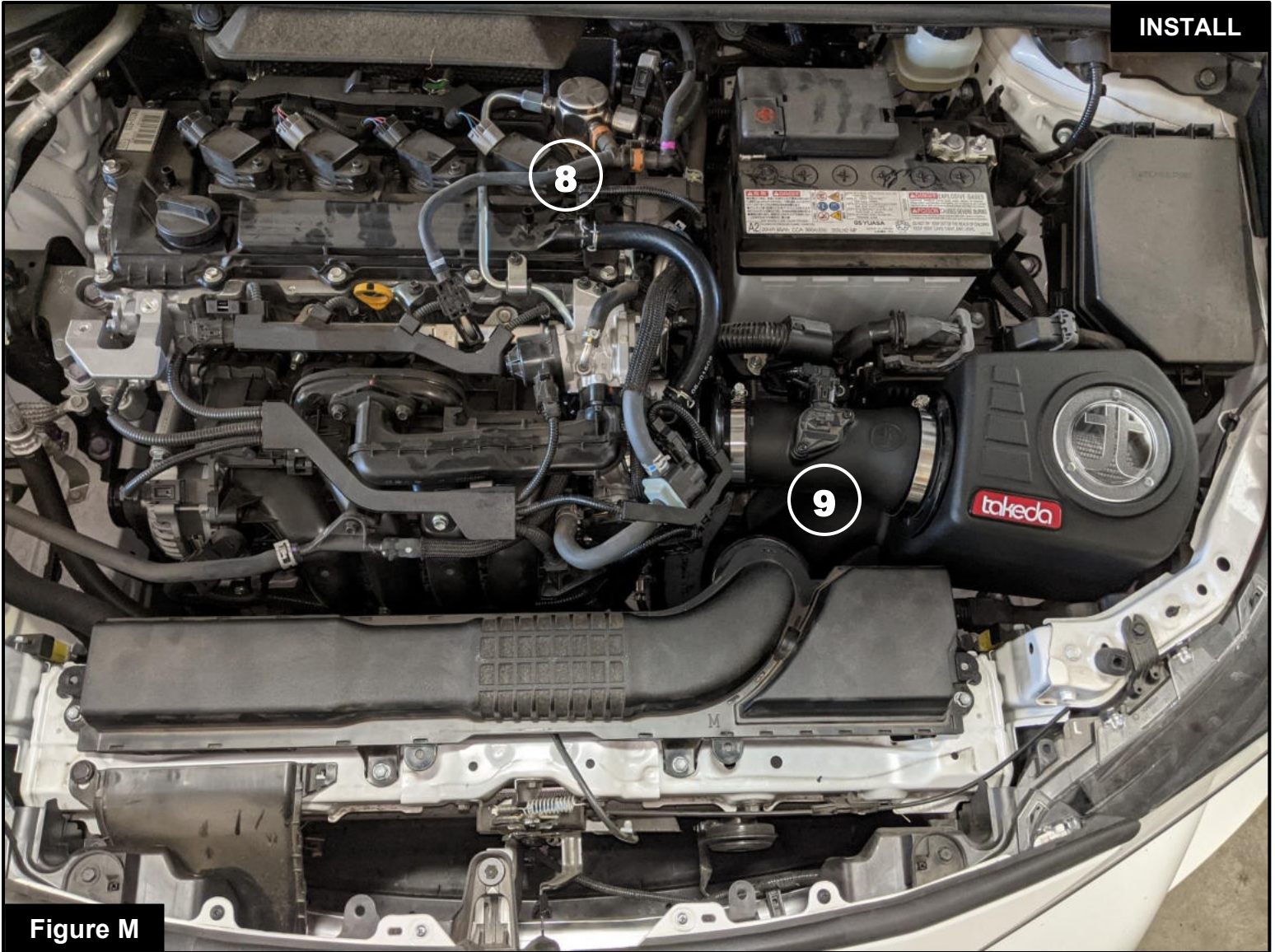

Figure L

**Refer to Figure L for Step 19**

Step 19: Install the silicone inlet sleeve onto the housing scoop, as shown. Make sure it is fully seated.

**Figure M****Refer to Figure M for Steps 20-23**

Step 20: Attach the other end of the hose to the PCV port on top of the engine, where the factory hose was disconnected at Step 8. Use the other clamp to secure the line. ⑧

Step 21: Angle the tube downward so it fits inside the air filter flange, as shown. Align the tube, the coupling, and the filter. Tighten down all of the clamps.

Step 22: Install the MAF sensor onto the Takeda tube using the provided M4 screws and a T20 Torx screwdriver. Reconnect the plug to the sensor. ⑨

Step 23: Reinstall the air inlet, making sure the inlet falls into the scoop on the housing. Fasten the inlet using the screws removed in Step 2.



Figure N

**Refer to Figure N for Steps 24-25**

Step 24: Reinstall the front cover using the hardware removed in Step 1.

Your installation is now complete. Thank you for choosing Takeda.



Pro DRY S Air Filter



P/N: 21-91103

Pro 5R Air Filter



P/N: 24-91103

Pro DRY S Restore Kit



P/N: 90-59999

Pro 5R Restore Kit



P/N: 90-50501

Pro DRY S Power Cleaner



P/N: 90-10101

Pro 5R Power Cleaner



P/N: 90-10201

Pre-Filter



P/N: 28-10083

Takeda Man Decal



P/N: TP-7003D

To purchase any of the items above, view airflow charts, dyno graphs, photos, and video; please go to [aFepower.com](http://aFepower.com).



# Warranty

## General Terms:

- aFe warrants their products to be free from manufacturer's defects due to workmanship and material.
- This warranty applies only to the original purchaser of the product and is non-transferrable.
- Proof of purchase of the aFe product is required for all warranty claims.
- Warranty is valid provided aFe instructions for installation and/or cleaning were properly followed.
- Proper maintenance with regular inspections of product is required to insure warranty coverage.
- Damage due to improper installation, abuse, unauthorized repair or alteration is not warranted.
- Incidental or consequential damages or cost, including installation and removal of part, incurred due to failure of aFe product is not covered under this warranty.
- All warranty is limited to the repair and/or replacement of the aFe part. To request Return Goods Authorization ("RGA"), email RGA@afepower.com or call (951)493-7100. Upon receipt of the RGA, you must return the product to the address provided in the RGA, freight prepaid and accompanied with a dated proof of purchase and the RGA. Upon receipt of the defective product and upon verification of proof of purchase, aFe will either repair or replace the defective product within a reasonable time, not to exceed thirty days.

Product Category	P/N Prefix	Warranty duration
Direct OE Replacement Filters	10, 11, 30, 31, 71, 73	Life of the vehicle
Racing Filters	18	1 year
Universal	21, 23, 24, 72, TF	2 years
Air Intake Systems	50, 51, 53, 54, 55, 56, 57, 58, 75, TR, TA, TL, TM	2 years
Exhaust Systems	49	2 years
Intercoolers & Intercooler Tubes	46-2	2 years
Intake Manifolds	46-1	2 years
Differential Cover	46-7	Life of the vehicle
Exhaust Manifolds	46	2 years
Throttle Body Spacers	46-3	2 years
Turbochargers	46-6	2 years*
Fluid Filters	44	90 days
Pre-Filters	28	2 years
Heavy Duty OE Replacement	70	2 years
PowerSports OE Replacement	81, 87	2 years
PowerSports Intake Systems	85	2 years

No other warranty expressed or implied applies nor is any person or advanced FLOW engineering authorized to assume any other warranty. Some States do not allow the exclusion or limitation of incidental or consequential damages or do not allow limitations on how long an implied warranty lasts, so the above limitations or exclusions may not apply to you. This warranty gives you specific legal rights, and you may also have other rights which vary from State to State.

\*See turbocharger warranty for more info



***advanced FLOW engineering, inc.***

252 Granite Street Corona, CA 92879  
TEL: 951.493.7100 • TECH: 951.493.7185  
E-Mail: Tech@aFepower.com

P/N: 06-81281